

Plows

Accessory 69 - 1/4" x 5/8"
Accessory 19 - 1/4" x 1"
Accessory 11 - 1/4" x 1 1/4"
Accessory - 72 x 1 3/8"
Accessory 24 - 1/4" x 1 3/4"
Accessory 13 - 1/8" x 1"
Accessory 39 - 3/8" x 13/16"
Accessory 49 - 3/8" x 3/4"
Accessory 21 - 1/4" x 4 3/4"

Note - These are the sizes we have. Custom setups can be done to achieve most all other sizes. Plow availability depends on application.

Radiuses

Arches, Ellipses, and Circles are available to match straight mouldings up to 4" wide.

EE (Eased edges)

3001 - 3/4" Radius
3002 - 1/8" Radius
3003 - 1/4" Radius
3028 - 7/16" Radius
3037 - 1/16" Radius
3076 - 3/8" Radius
Accessory 48 - 1/2" Radius
Accessory 52 - 3/32" Radius

Eased edge availability depends on application.

Custom knives

Can't find the profile you want? We offer in-house knife grinding to create or match any profile.

Sheet goods

Sheet goods are available by custom order.

Bevels

Accessory 60 - 45° Bevel (Used for smaller applications)
Accessory 1 - 45° Bevel (Used for most applications)
Accessory 10 - 45° Bevel (Used for larger applications)
Accessory 3 - 38 1/2° Bevel (Used for most applications)
Accessory 44 - 38 1/2° Bevel (Used for larger applications)
Accessory 2 - 52 1/2° Bevel (Used for most applications)
Accessory 45 - 52 1/2° (Used for larger applications)
Accessory 7 - 40° Bevel
Accessory 59 - 59° Bevel

Note - Bevel availability depends on application.

S4S

S4S - Straight 4 sides.

S4S can be made up to 9" wide through the moulder. Wider sizes are available using planers and sanders.

Rosettes

Rosettes can be made from 2 1/4" to 5" square. Other styles and sizes are available upon request.

Stair Accessories

Hand Rails - Bendable, straight and solid, solid treads, tread caps, end caps and risers.

Mantels & Custom furniture

Custom designs & parts.

Custom projects

We specialize in custom millwork and special projects.

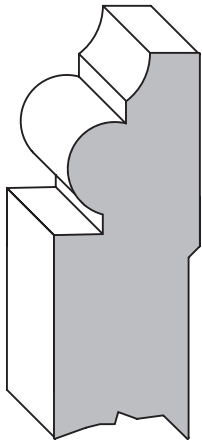

1000
3/4" thick
up to
4 1/4" wide

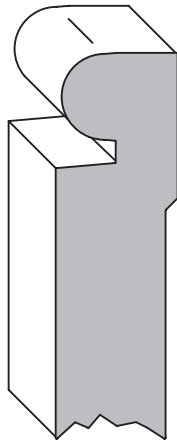

1001
5/8" thick
up to
6 1/2" wide

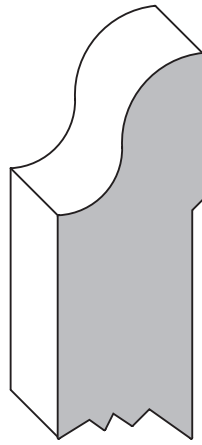

1004
3/4" thick
up to 9" wide

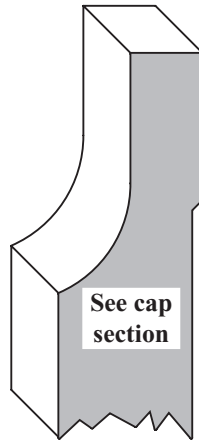

1005
3/4" thick
up to 6" wide

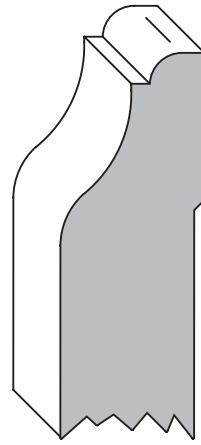

1007
3/4" thick
up to
4" wide

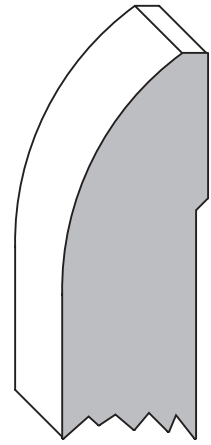

1008
3/4" thick
up to 4" wide

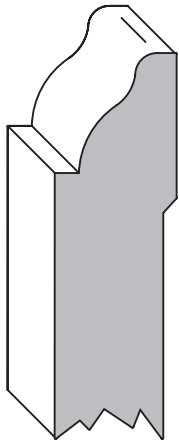

1011
5/8" thick
up to 9" wide

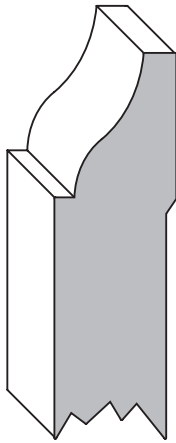

1012
5/8" thick
up to 9" wide

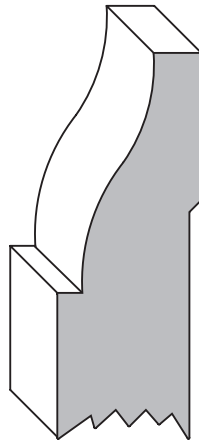

1013
3/4" thick
up to 6" wide

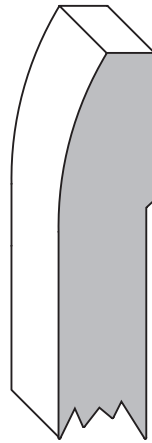

1018
1/2" thick
up to
3 1/4" wide

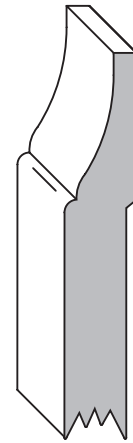

1019
3/8" thick
up to
9" wide

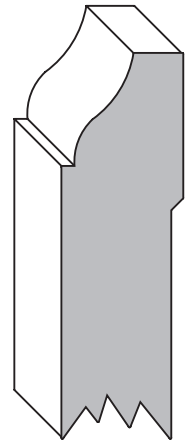

1022
5/8" thick
up to 9" wide

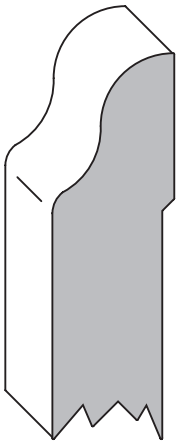

1031
5/8" thick
up to 9" wide

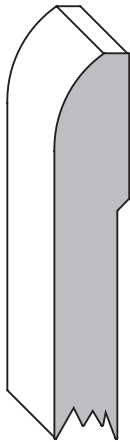

1033
3/8" thick
up to
9" wide

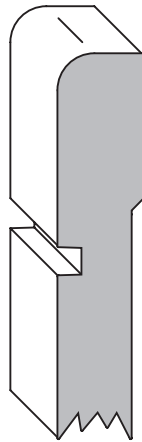

1035
7/16" thick
up to
7 1/2" wide

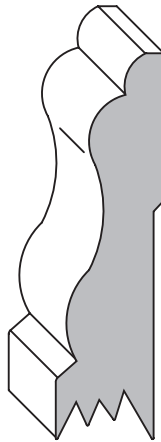

1037
9/16" thick
up to
4 1/2" wide

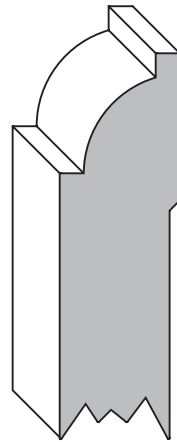

1053
5/8" thick
up to
9" wide

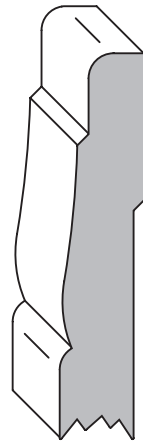

1054
7/16" thick
up to
5" wide



1066
3/8" thick
up to
5" wide

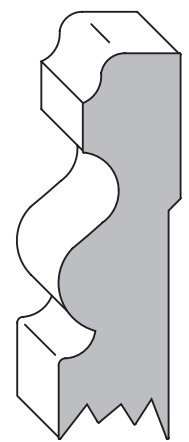

1068
5/8" thick
up to 6" wide

Base

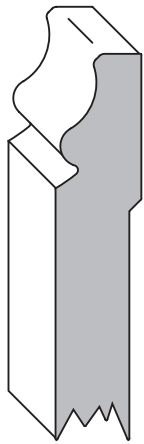

3070
7/16" thick
up to
4 1/4" wide

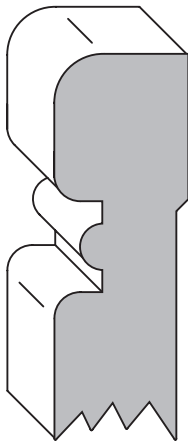

2009
11/16" thick
up to 6" wide

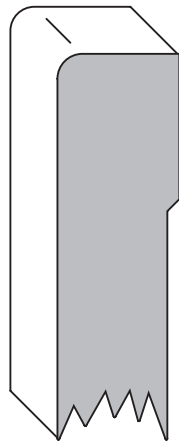

E1E 1/8" Base
5/8" thick
up to 9" wide

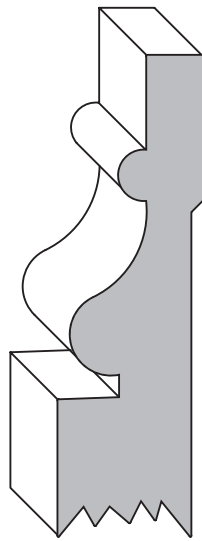

1002
3/4" thick
up to 4" wide

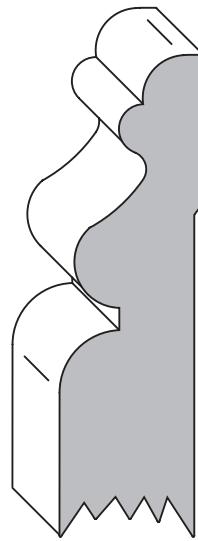

1009
3/4" thick
up to 7" wide

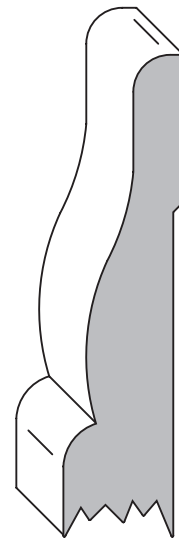

1027
5/8" thick
up to 5" wide

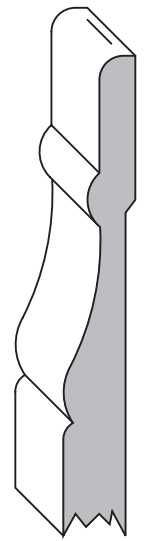

1020C
3/8" thick
up to
3 1/4" wide

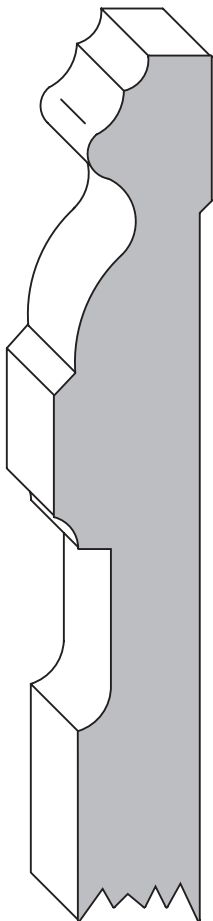

1003
13/16" thick
up to
4 5/8" wide

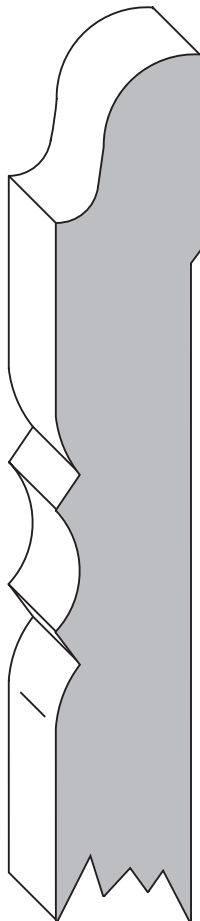

1010
3/4" thick
up to
6" wide

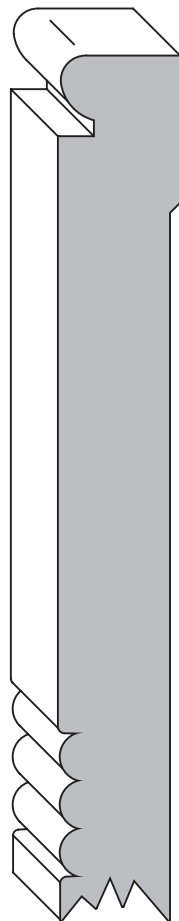

1025
5/8" thick
up to
6" wide

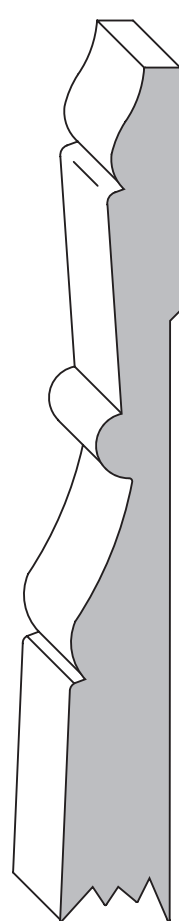

1036
5/8" thick
up to
4 7/16" wide

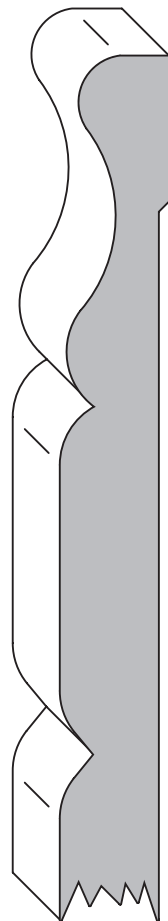

1043
9/16" thick
up to
5 1/2" wide

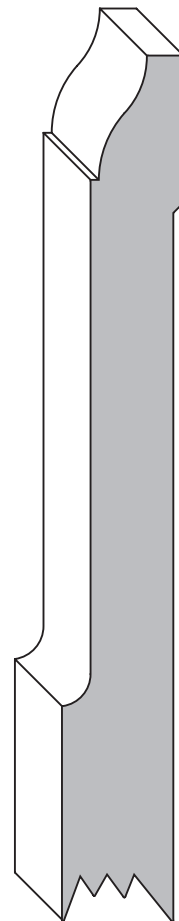

1045
5/8" thick
up to
5 1/2" wide

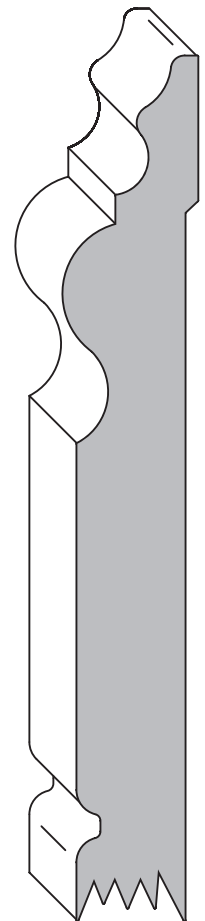

1062
5/8" thick
up to
6" wide

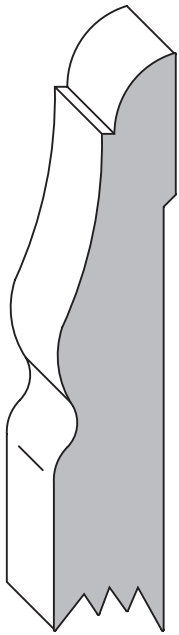

1014
5/8" thick
up to
7" wide

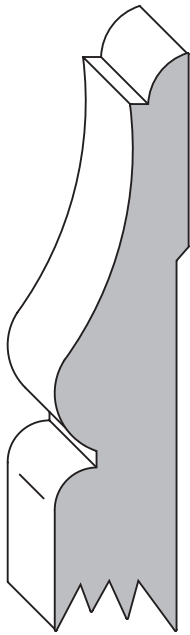

1021
11/16" thick
up to
7" wide

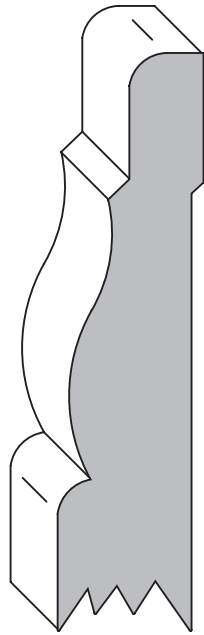

1023
3/4" thick
up to
6" wide

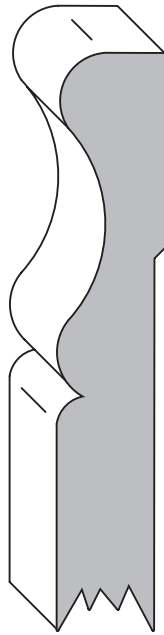

1029
9/16" thick
up to
4 1/2" wide

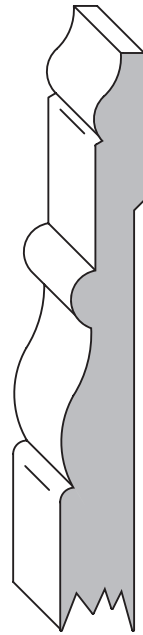

1038
7/16" thick
up to
3 1/4" wide

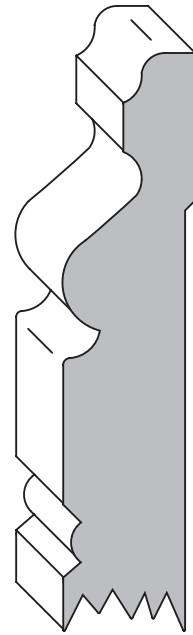

1040
11/16" thick
up to
5 1/4" wide

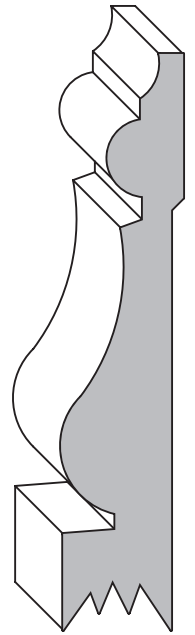

1044
5/8" thick
up to 5" wide

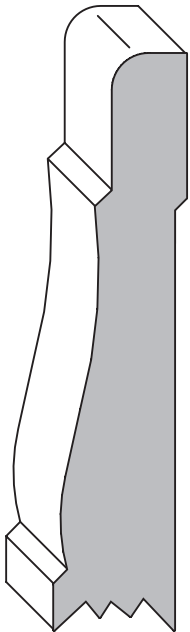

1046
11/16" thick
up to
3 1/2" wide

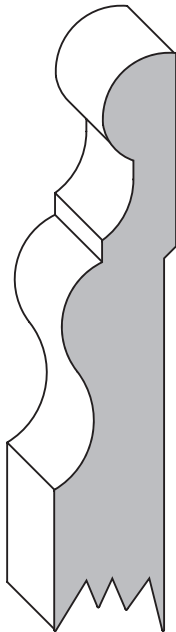

1059
5/8" thick
up to
7" wide

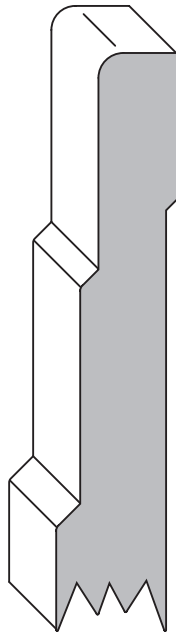

1061
5/8" thick
up to
6" wide

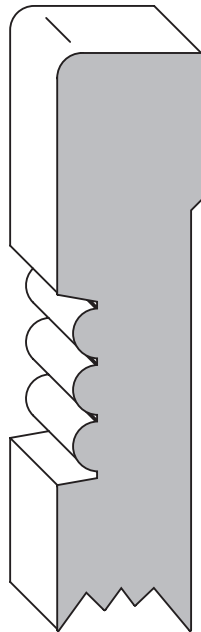

1063 w/ E1E 1/8"
3/4" thick
up to
6" wide

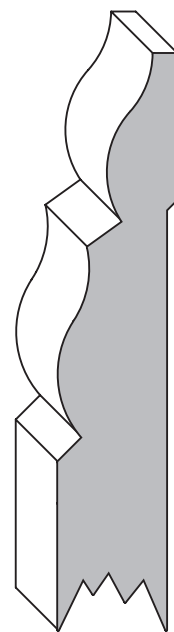

1067/ 2007
5/8" thick
up to
5 1/2" wide

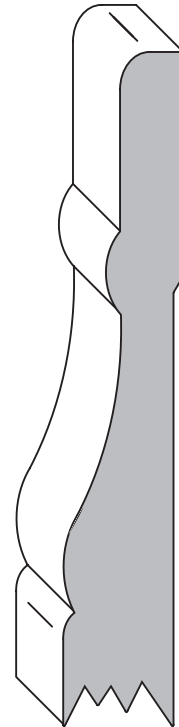

1020B
5/8" thick
up to
5" wide

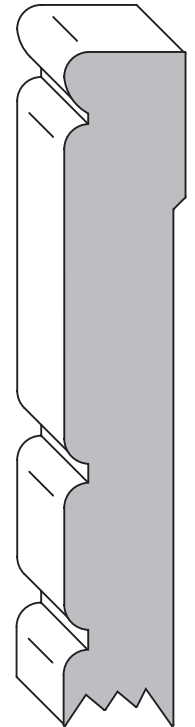

1024
5/8" thick
up to
5 1/2" wide

Base

Wood Originals

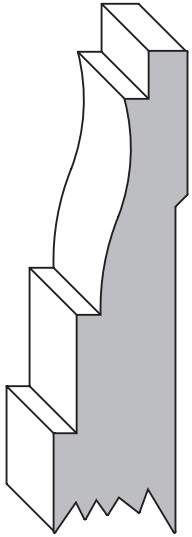

1028
11/16" thick
up to 7" wide

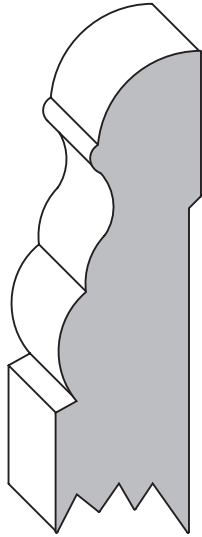

1047
3/4" thick
up to 6 1/2" wide

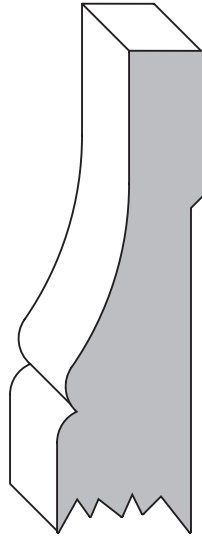

1056
3/4" thick
up to 7 1/2" wide

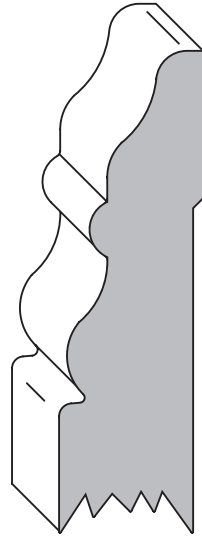

1058
3/4" thick
up to 6" wide

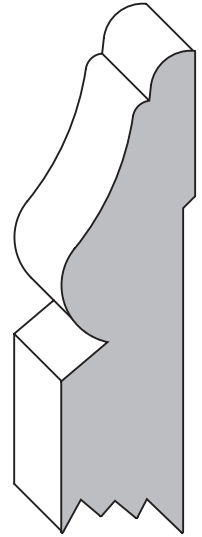

1057
11/16" thick
up to 7" wide

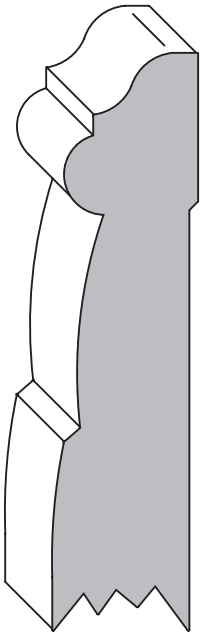

1006
3/4" thick
up to 7" wide

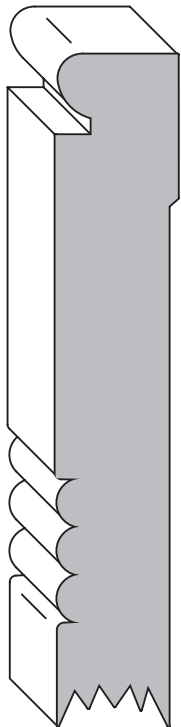

1030
5/8" thick
up to
4 1/2" wide

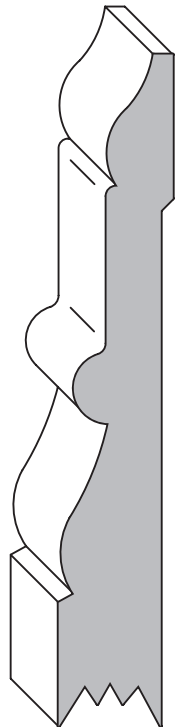

1039
9/16" thick
up to 4" wide

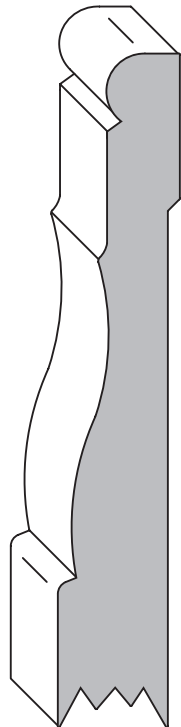

1055
5/8" thick
up to 6" wide

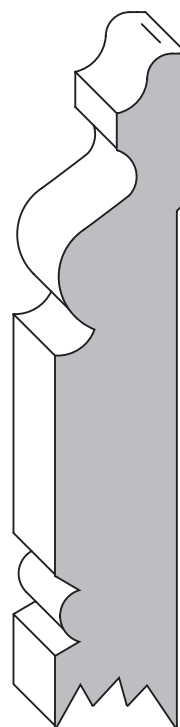

1070
11/16" thick
up to 6" wide

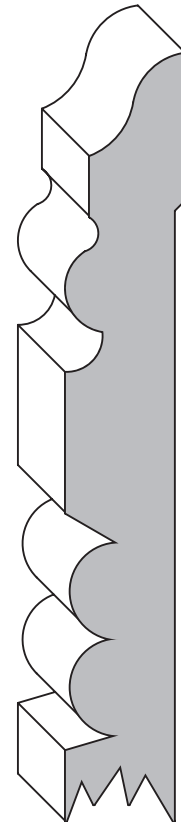

1041
5/8" thick
up to 6" wide

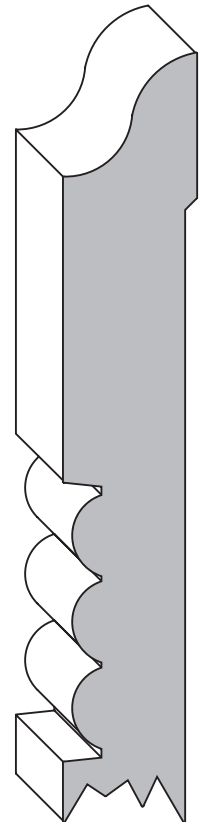

1048 (Beads)
1049 (Nose)
11/16" thick
up to 5 3/16" wide

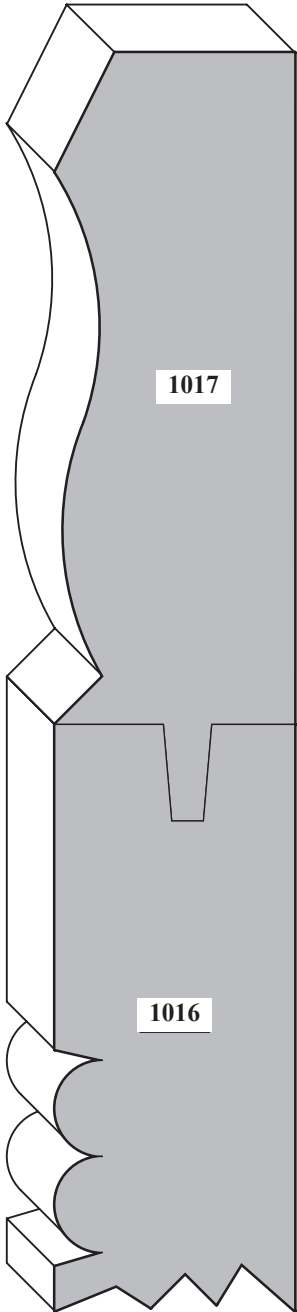

1017

1016

1016/1017
 1 1/4" x 3 1/2" (top)
 Add 1/2" for tongue
 Bottom can be
 made up to 6 1/2" wide

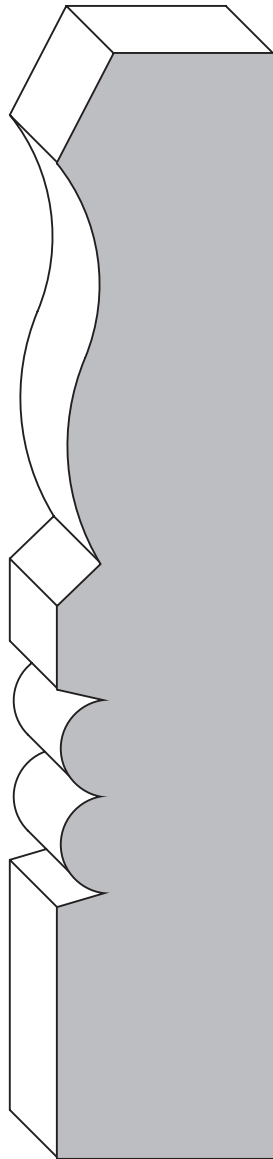

1042
 1 1/8" x 5 3/4"
 (up to 6 3/4" wide)

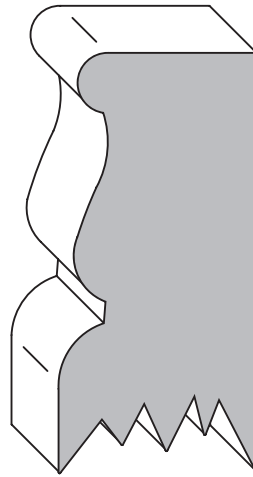

1034
 1" x
 (up to 8" wide)

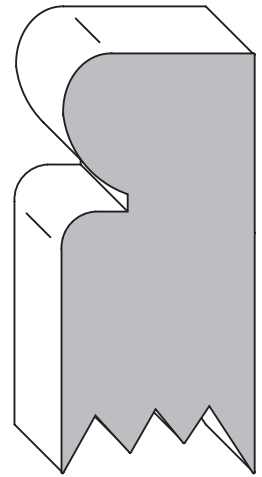

1026
 1" x
 (up to 8" wide)

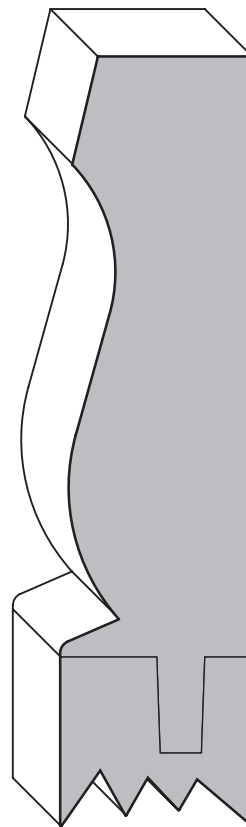

1060
 1" x 3 1/8" (Top)
 Add 1/2" for tongue
 Bottom can be
 made up to 9".

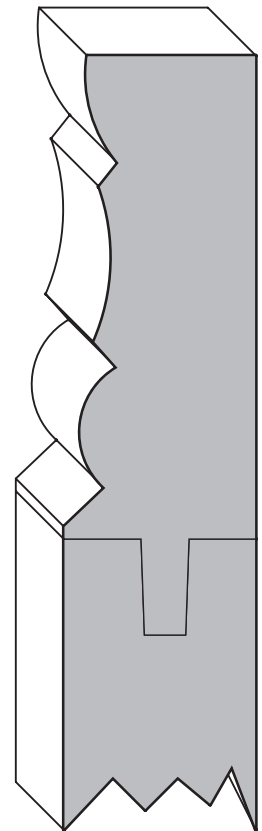

1015
 1" x 2 7/16" (Top)
 Add 1/2" for tongue
 Bottom can be
 made up to 9" wide

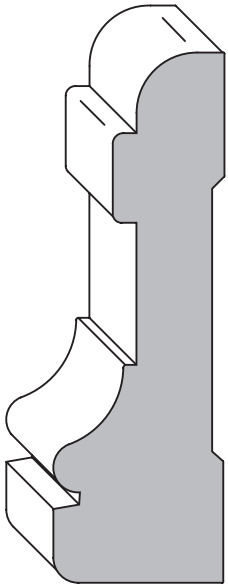

2001
w/ E1E 1/8"
7/8" x
(2 3/4" max.)

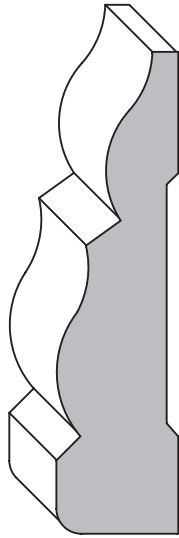

2007
w/ E1E 1/8"
5/8" x
(5 1/2" max.) See 1067

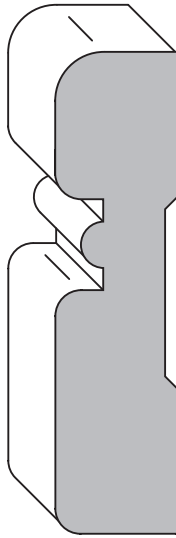

**2009 w/
E1E 1/8"**
11/16" x
(6" max.)

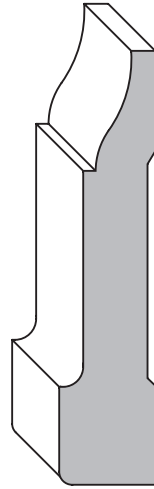

2011
w/ E1E 1/8"
1/2" x
(2 1/4" max.)

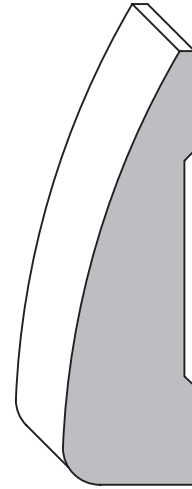

2012
w/
E1E 1/4"
11/16" x
(2 1/4" max.)

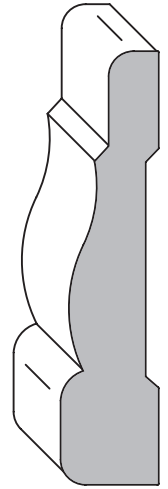

**2013 w/
E1E 1/8"**
1/2" x
(2 1/4" max.)

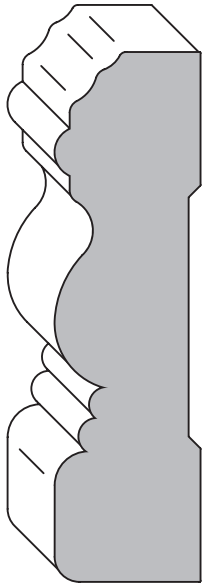

2018
w/ E1E 1/8"
3/4" x
(2 3/4" max.)

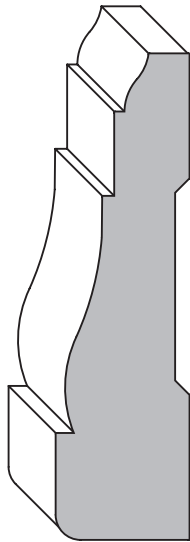

2021
w/ E1E 1/8"
11/16" x
(2 1/2" max.)

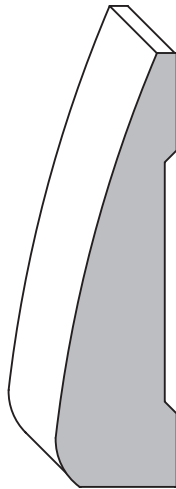

2023
5/8" x
(2 1/4" max.)

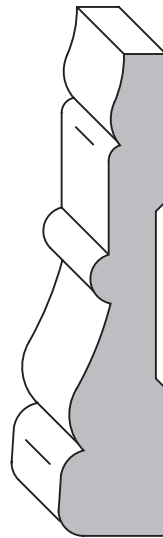

**2024 w/
E1E 1/8"**
9/16" x
(2 1/2" max.)

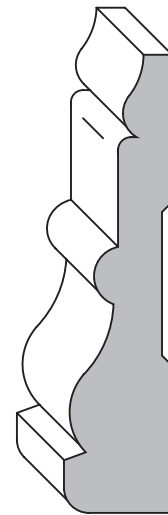

2026
w/
E1E 1/8"
9/16" x
(2 3/8" max.)

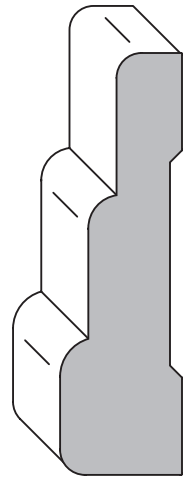

**2032 w/
E1E 1/8"**
5/8" x
(2 3/16" max.)

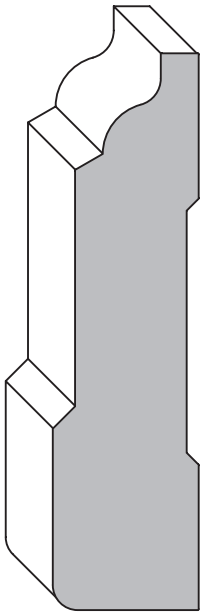

**2033 w/
E1E 1/8"
3/4" x
(2 7/8" max.)**

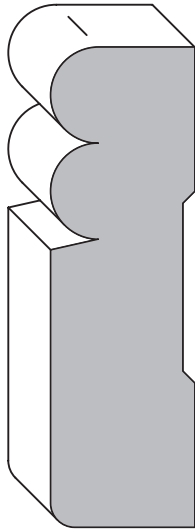

**2041 w/
E1E 1/8"
3/4" x
(2 1/2" max.)**

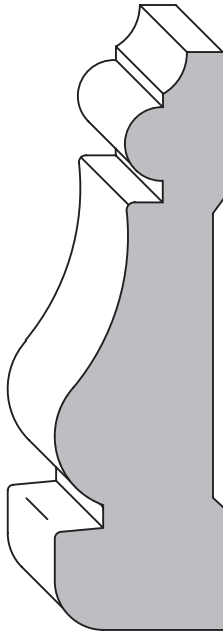

**2000 w/ E1E 1/4"
7/8" x
(3" max.)**

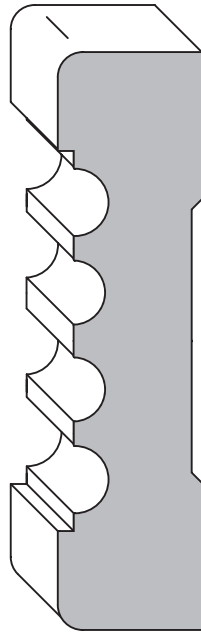

**2003
w/ E2E 1/8"
3/4" x
(3" max.)**

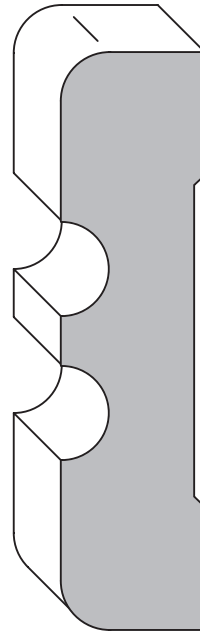

**2004
w/ E2E 1/4"
3/4" x
(3" max.)**

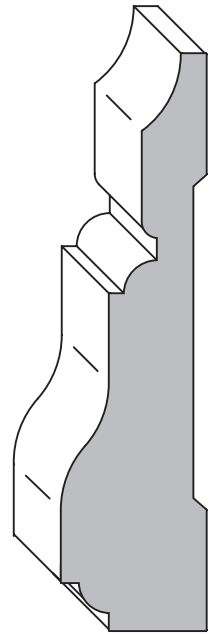

**2006
3/4" x
(3" max.)
Plinths
may be needed.**

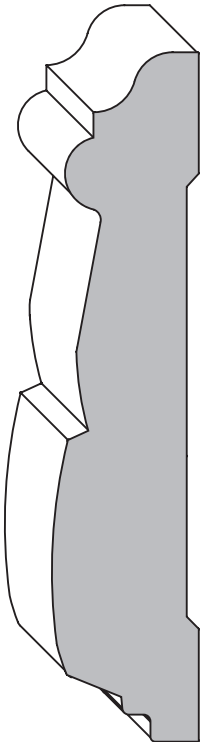

**2002
3/4" x
(3 5/8" max.)**

Plinths may be needed.

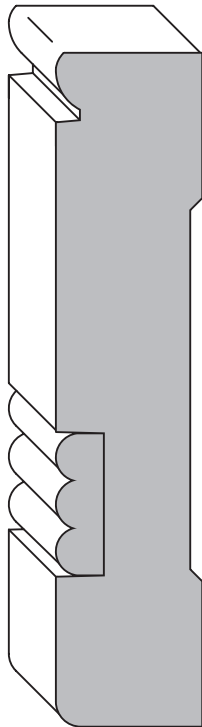

**2014 & Inlay w/ E1E 1/8"
3/4" x
(3 1/2" max.)**

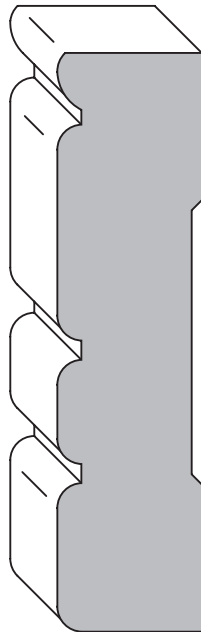

**2015
w/ E1E 1/8"
3/4" x
(3" max.)**

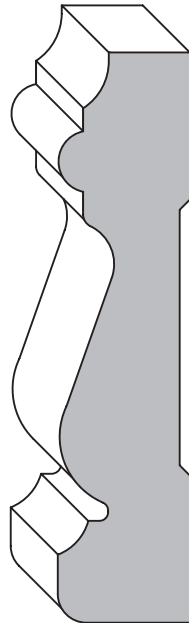

**2016
w/ E1E 3/16"
11/16" x
(2 15/16" max.)**

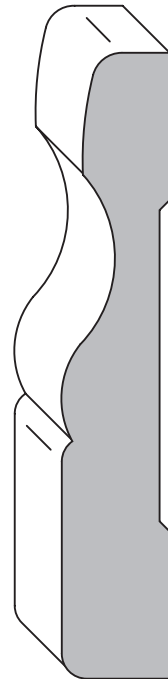

**2017
w/ E1E 1/8"
9/16" x
(3 1/4" max.)**

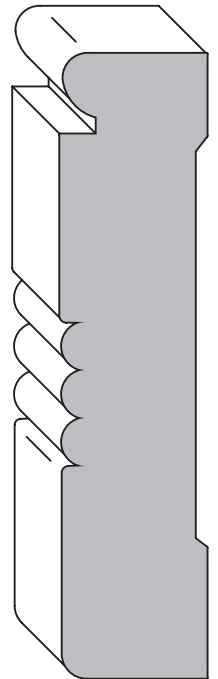

**2019
w/ E1E 1/8"
3/4" x
(3 1/4" max.)**

Case

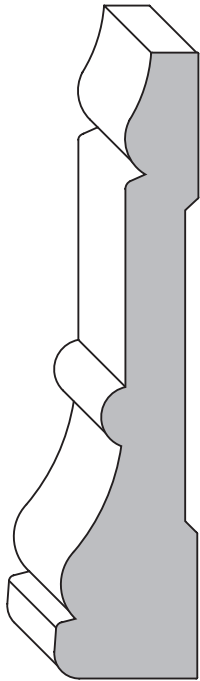

2025
w/ E1E 1/8"
3/4" x
(3 1/4" max.)

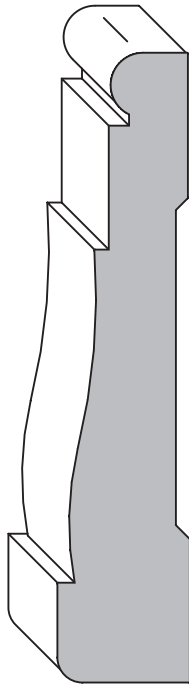

2028
w/ E1E 1/8"
11/16" x
(3 3/4" max.)

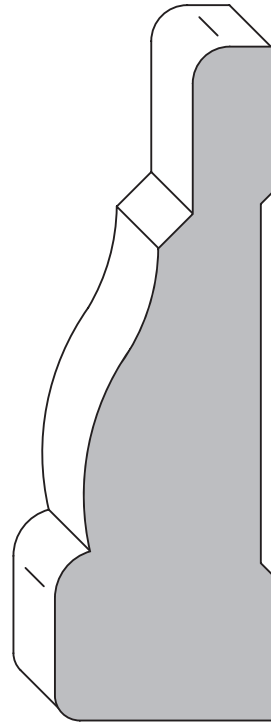

2039
w/ E1E 1/8"
1 1/8" x
(3 1/2" max.)

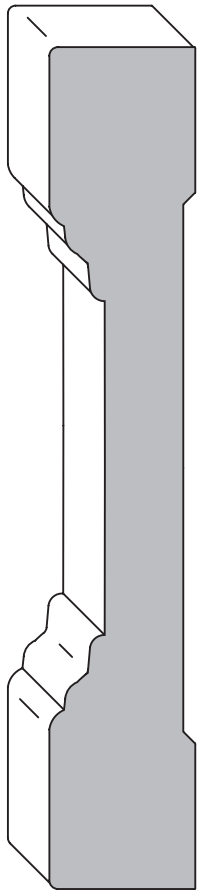

2040
w/ E2E 1/16"
3/4" x
(4 3/8" max.)

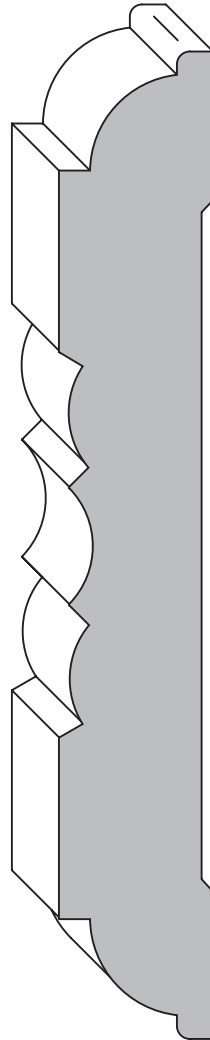

2010 (top)
3025 (sides)
13/16" x
(5 1/8" max.)
Plinths may be needed.

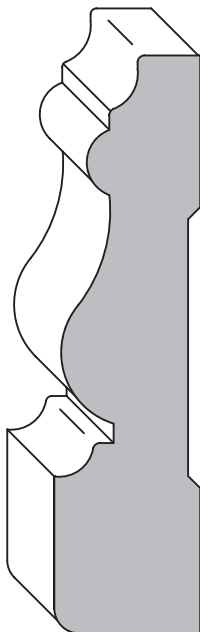

2027
w/ E1E 1/8"
3/4" x
(3" max.)

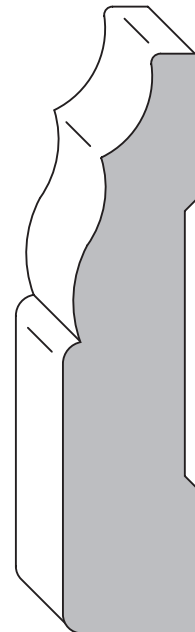

2029 w/
E1E 1/8"
11/16" x
(5" max.)

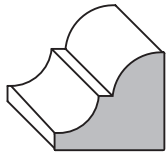

3007
1/2" x
9/16"
(Splitter)

(No size alterations)



3035
3/8" x
(15/16" max.)

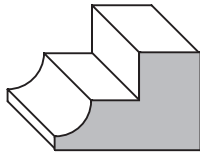

3039
1/2" x 3/4"

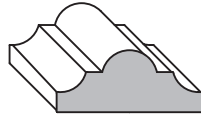

7000
5/16" x
(3/4" max.)

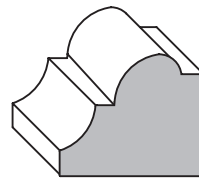

7001
5/8" x
(3/4" max.)

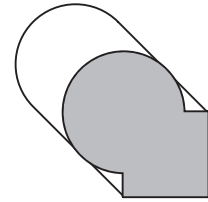

3064
5/8" x 15/16"
(No size alterations)

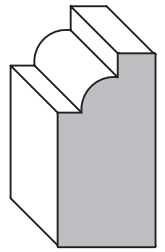

3068
1/2" x
(9" max.)

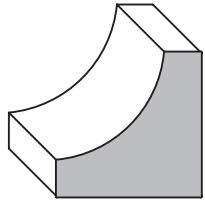

3000
(3/4" max.)
x 3/4"

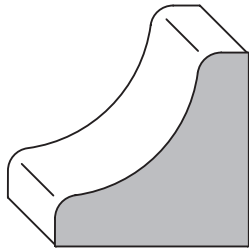

3012
(1" max.) x 1"

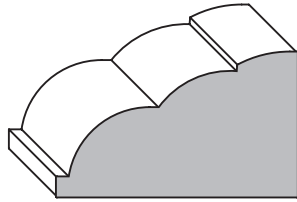

3041
3/4" x
(1 1/4" max.)

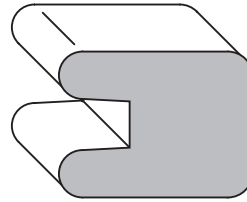

3047
(3/4" max.) x 1"

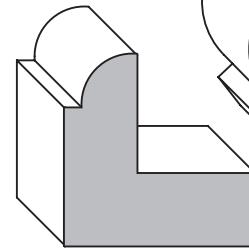

3050
1" x 1"
(No size alterations)

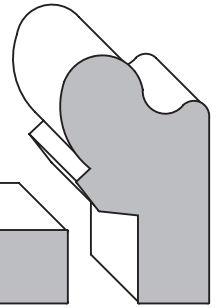

3069
3/4" x 1 5/16"
(No size alterations)

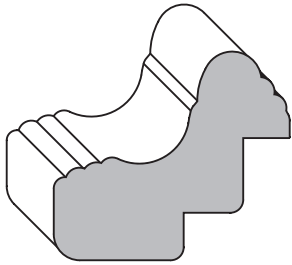

3057
(Picture frame)
11/16" x 1 3/8"
(No size alterations)

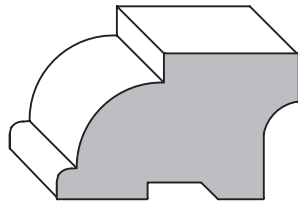

3059
3/4" x 1 1/4"
(No size alterations)

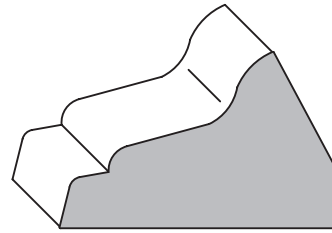

3067
15/16" X
1 7/16"
(No size alterations)

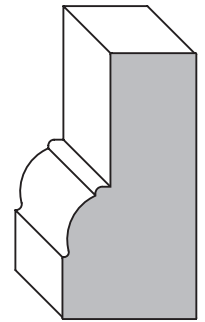

3063
11/16" x
(1 3/8" max.)

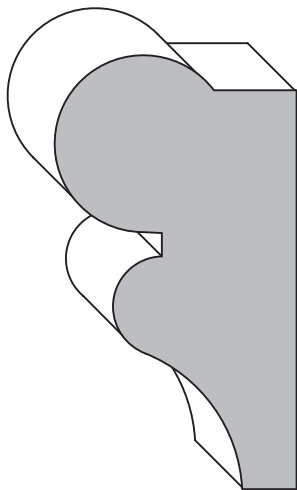

3055
1 1/4" x
(2 1/4" max.)

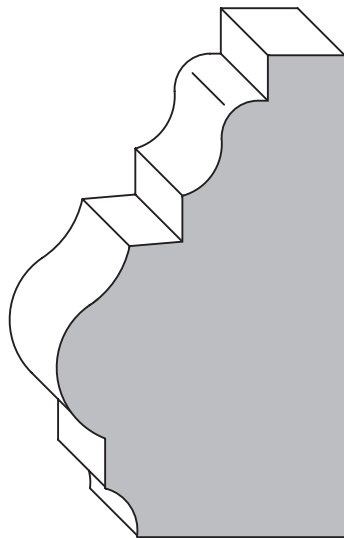

7002
1 1/2" x
(2 1/2" max.)

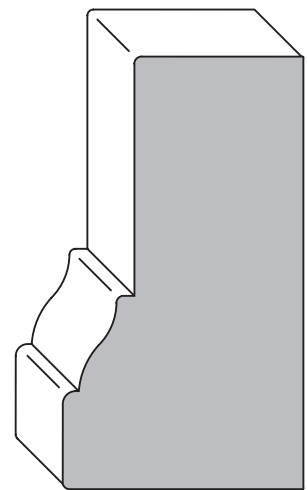

3052
1 1/4" x
(2 1/4" max.)

Trim &
Caps

Wood Originals

Phone: (970) 352-7688

10

Fax: (970) 352-7689

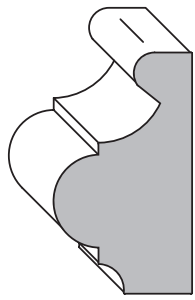

3014
3/4" x
(1 5/16" max.)

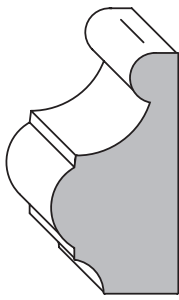

3042
1 1/16" x
(1 5/16" max.)

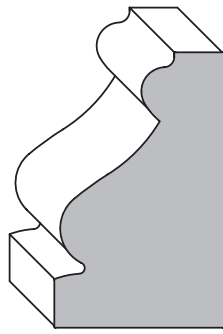

3046
1 5/16" x
(1 1/2" max.)

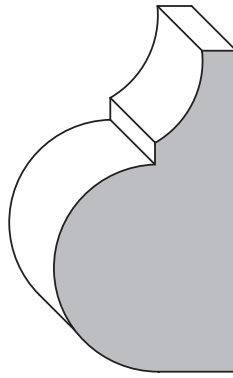

3048
1" x (1 3/4" max.)

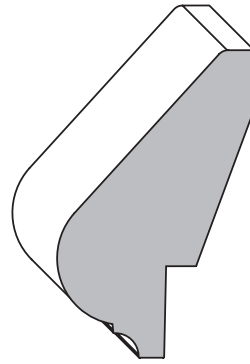

3049
w/ 1/2" rabbet only
3/4" x
1 13/16"
(No size alterations)

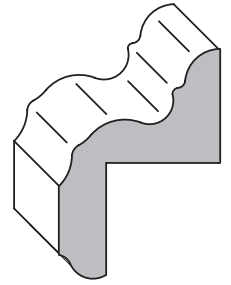

3056
w/ 5/8"
rabbet only
5/8" x
1 7/16"
(No size alterations)

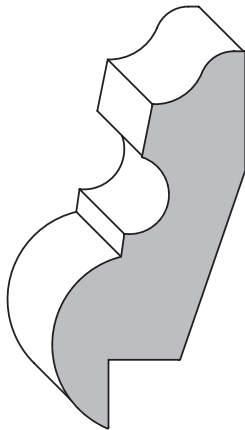

3027
w/ 1/2" or 3/4"
rabbet (Shown)
3/4" x 2 3/16"
(No size alterations)

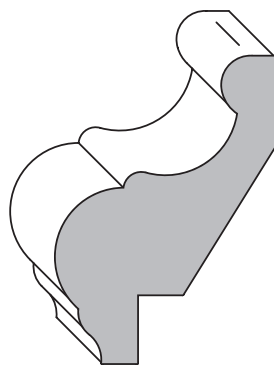

3029
w/ 3/4" rabbet only
3/4" x
1 15/16"
(No size alterations)

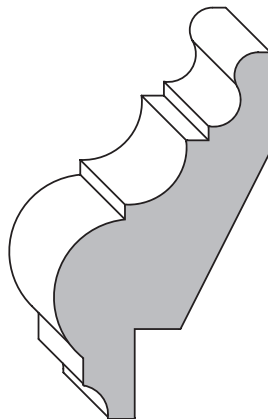

3031
w/ 3/4" rabbet only
3/4" x
2 3/16"
(No size alterations)

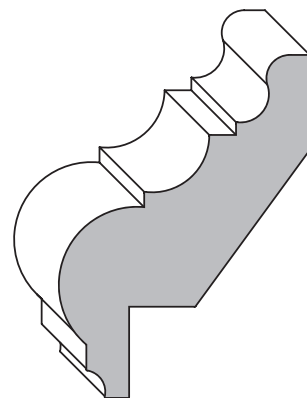

3032
w/ 1" rabbet only
3/4" x
2 3/16"
(No size alterations)

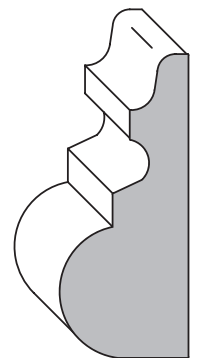

3072
3/4" x
(1 11/16" max.)

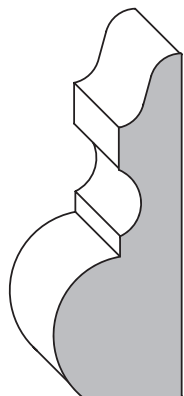

3066
1 1/16" x
(1 7/8" max.)
Rabbet availability
depends on profile

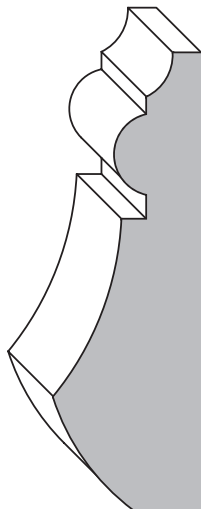

3015
1 3/16" x
(2 1/2" max.)

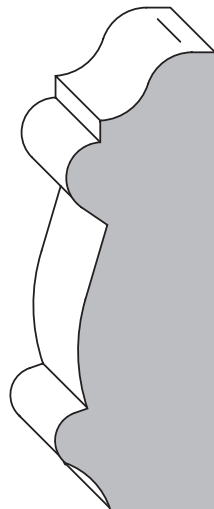

3016
7/8" x
(2 1/2" max.)

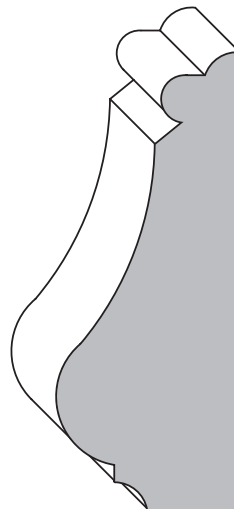

3017
1" x
(2 1/2" max.)

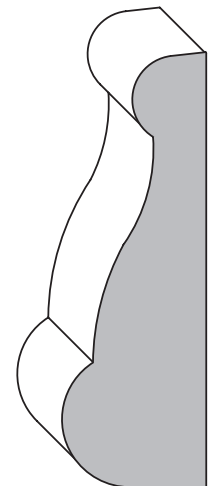

3060
3/4" x
(2 3/8" max.)

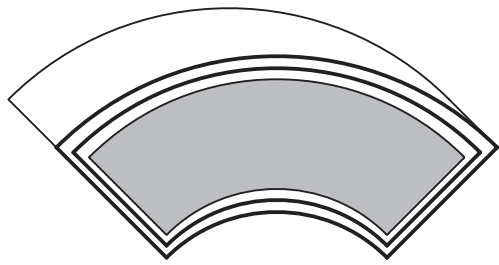

3009 13/16" sides
 3033 9/16" sides
 3034 11/16" sides

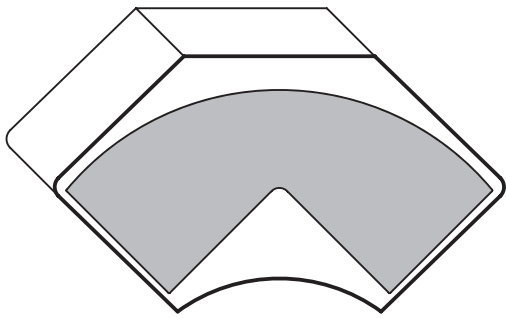

3040 (Hexagon) 3078 (Rounded)
 1 3/8" x 1 1/16" x
 2 3/8" 2 1/4"
 7/8" sides 3/4" sides

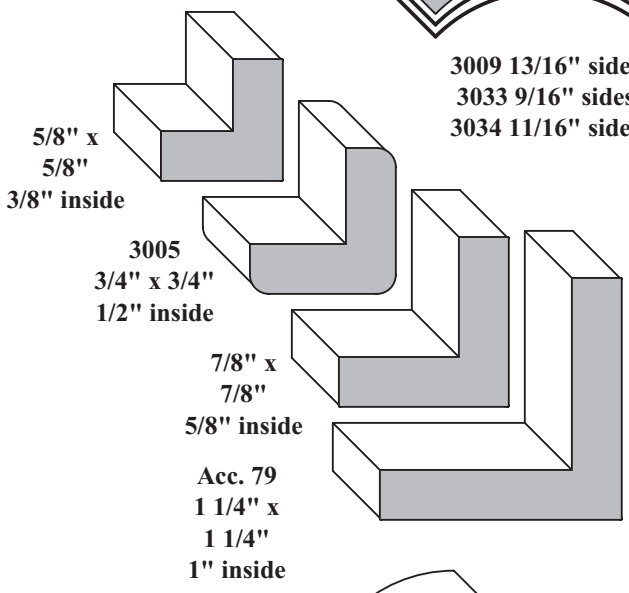

5/8" x 5/8"
 3/8" inside

3005
 3/4" x 3/4"
 1/2" inside

7/8" x 7/8"
 5/8" inside

Acc. 79
 1 1/4" x 1 1/4"
 1" inside

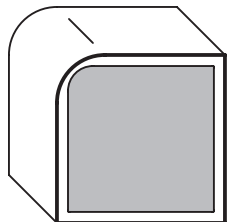

S4S E1E 1/4"
 7/8" x 7/8"

S4S E1E 1/8"
 3/4" x 3/4"

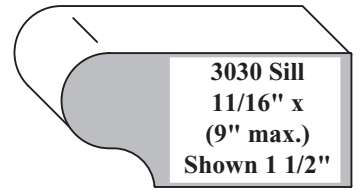

3030 Sill
 11/16" x (9" max.)
 Shown 1 1/2"

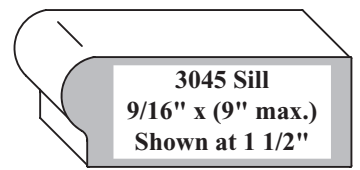

3045 Sill
 9/16" x (9" max.)
 Shown at 1 1/2"

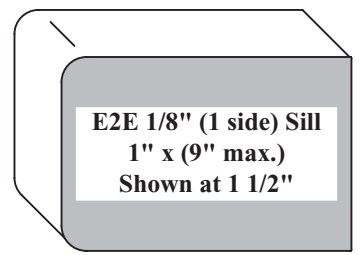

E2E 1/8" (1 side) Sill
 1" x (9" max.)
 Shown at 1 1/2"

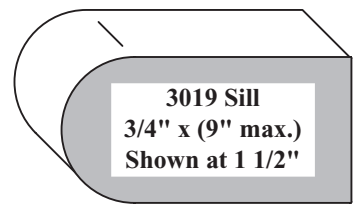

3019 Sill
 3/4" x (9" max.)
 Shown at 1 1/2"

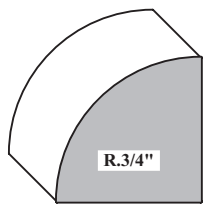

R.3/4"

3001
 3/4" x 3/4"

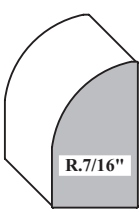

R.7/16"

3008
 7/16" x 3/4"

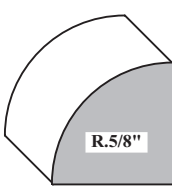

R.5/8"

3011
 5/8" x 5/8"

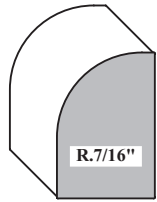

R.7/16"

3028
 1/2" x 3/4"

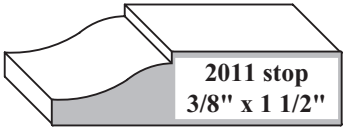

2011 stop
 3/8" x 1 1/2"

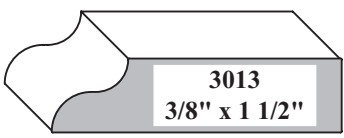

3013
 3/8" x 1 1/2"

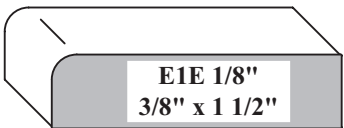

E1E 1/8"
 3/8" x 1 1/2"

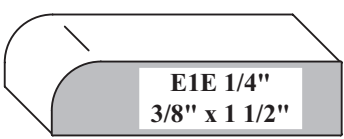

E1E 1/4"
 3/8" x 1 1/2"

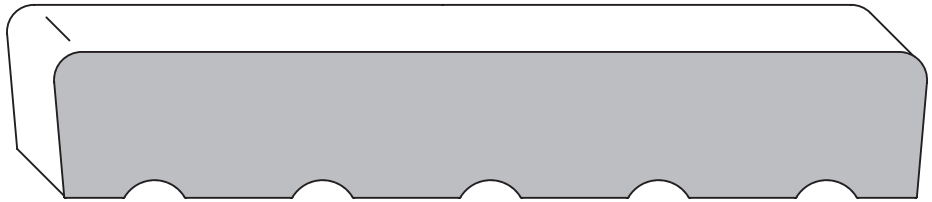

#17 Acc.
 3/4" x 4 9/16"
 Standard jamb
 (9" max.)

Door Acc.,
 Corners,
 Sills

Cornice

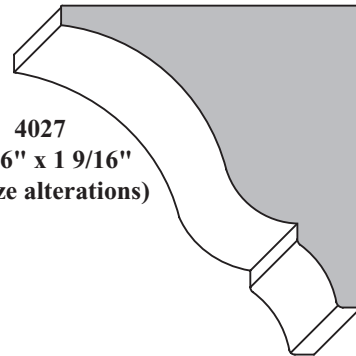
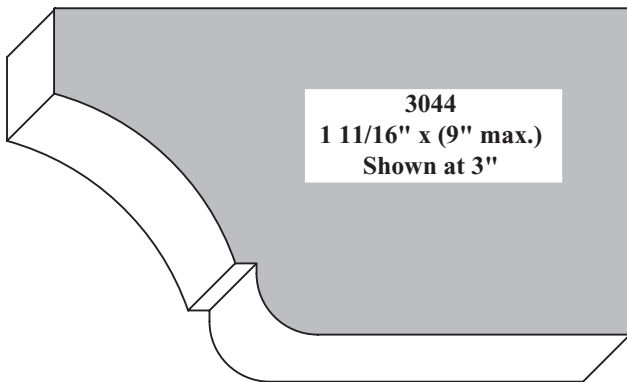
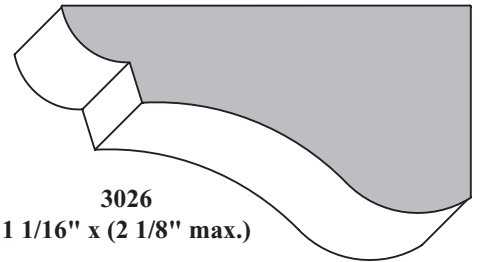
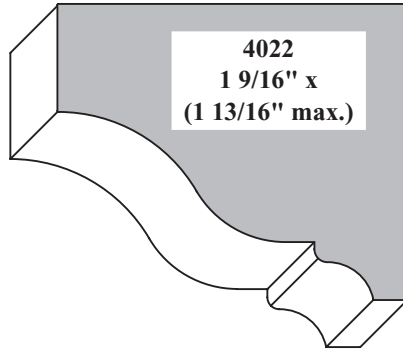
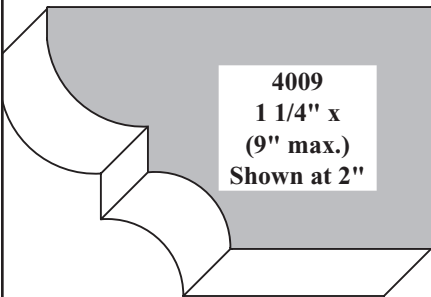
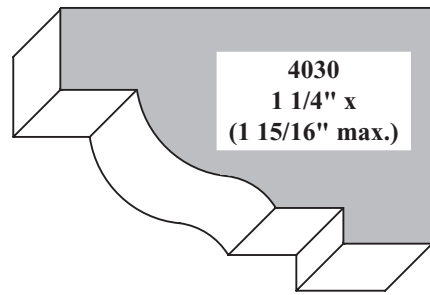
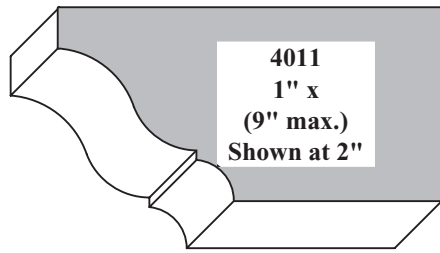
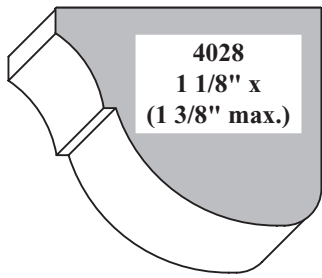

Crown

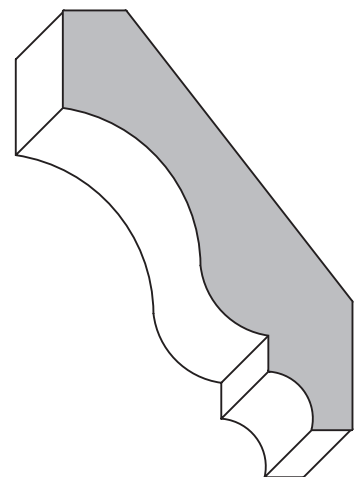
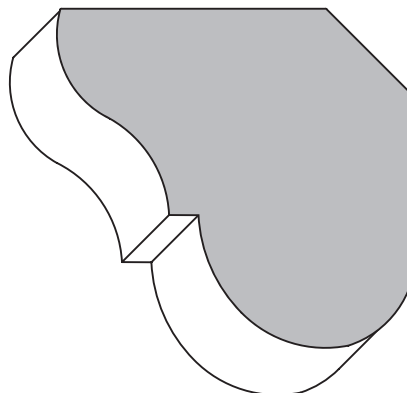
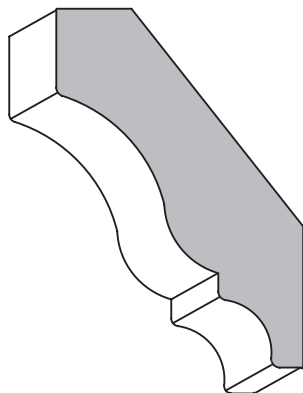
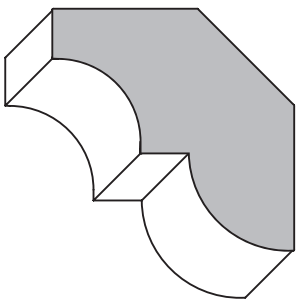

Crowns are not adjustable

Wood Originals

Phone: (970) 352-7688

13

Fax: (970) 352-7689

Cornice &
Crown

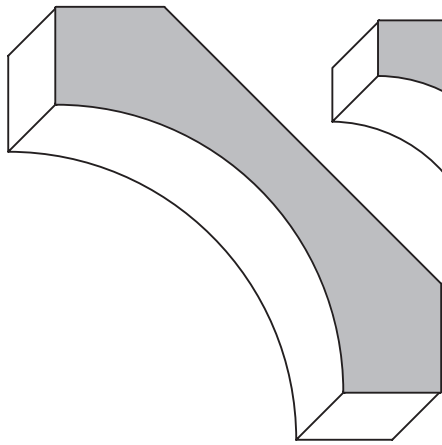

4029
 3/4" x 2 13/16"
 Height - 2"
 Proj. - 2"

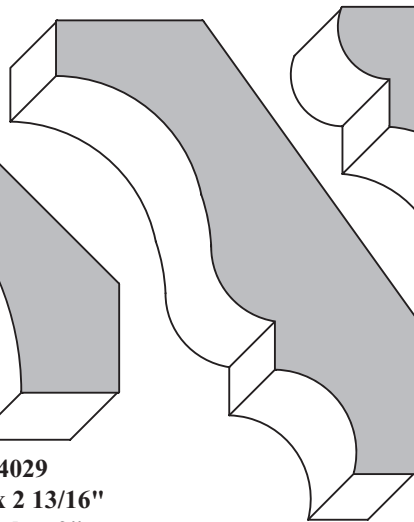

4001
 3/4" x 3"
 Height - 2 3/8"
 Proj. - 1 7/8"

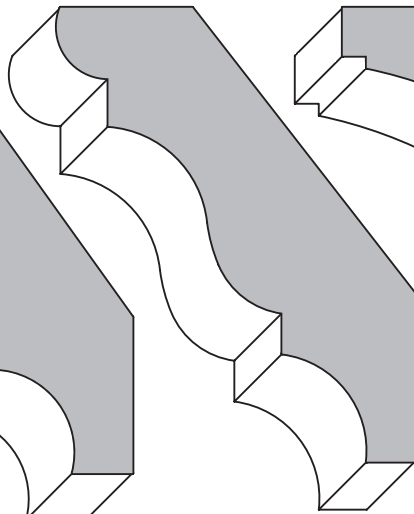

4002
 3/4" x 3"
 Height - 2 3/8"
 Proj. - 1 13/16"

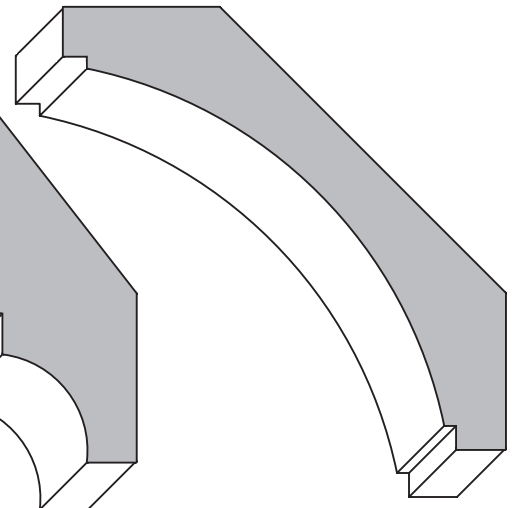

4032
 3/4" x 3 1/4"
 Height - 2 5/16"
 Proj. - 2 5/16"

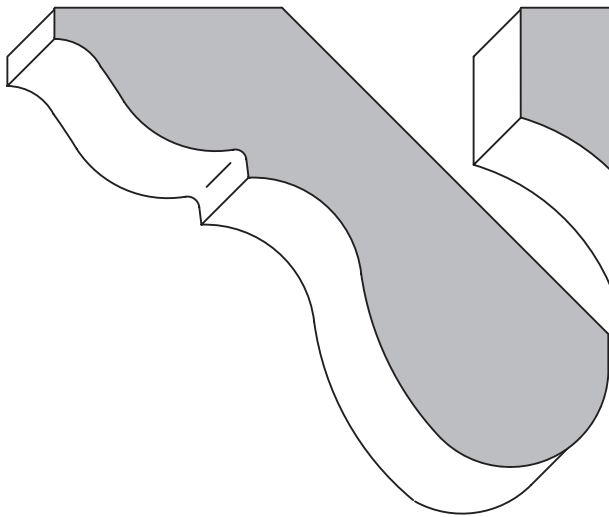

4024
 1" x 3 1/2"
 Height - 2 3/8"
 Proj. - 2 7/8"

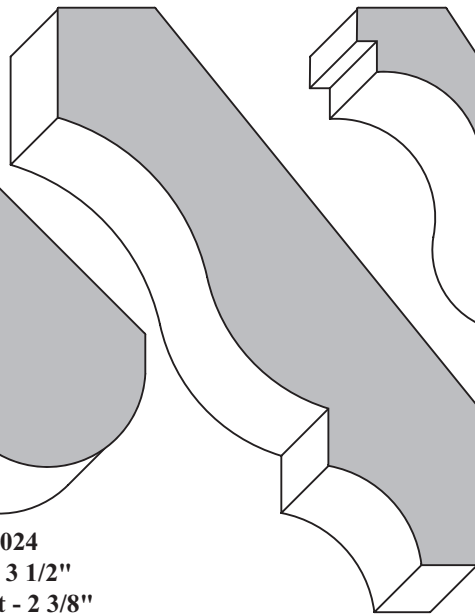

4004
 3/4" x 3 5/8"
 Height - 2 7/8"
 Proj. - 2 3/16"

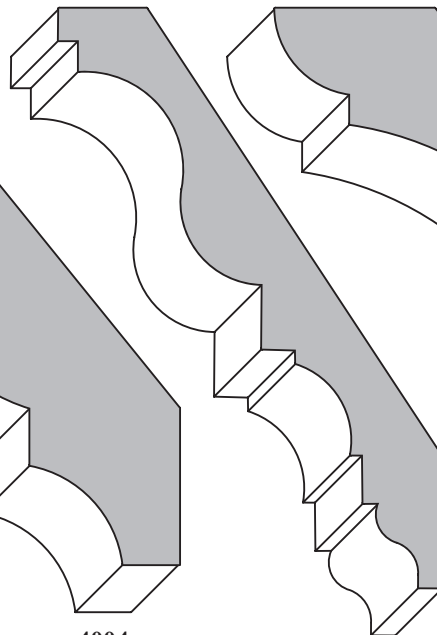

4016
 7/16" x 3 5/8"
 Height - 3"
 Proj. - 2"

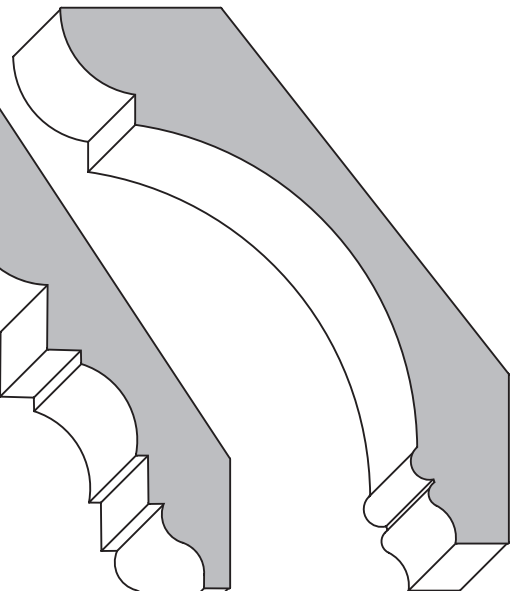

4018
 3/4" x 3 5/8"
 Height - 2 13/16"
 Proj. - 2 5/16"

Crowns are not adjustable

Crown

Wood Originals

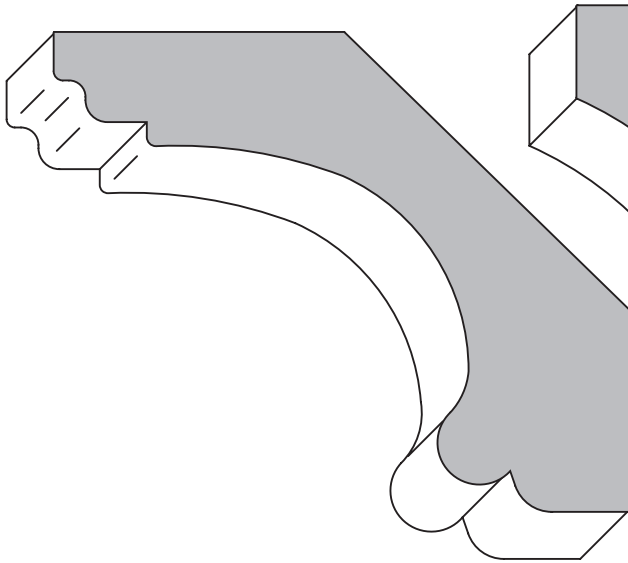

4023
1 1/4" x 3 7/8"
Height- 2 1/2"
Proj. - 3"

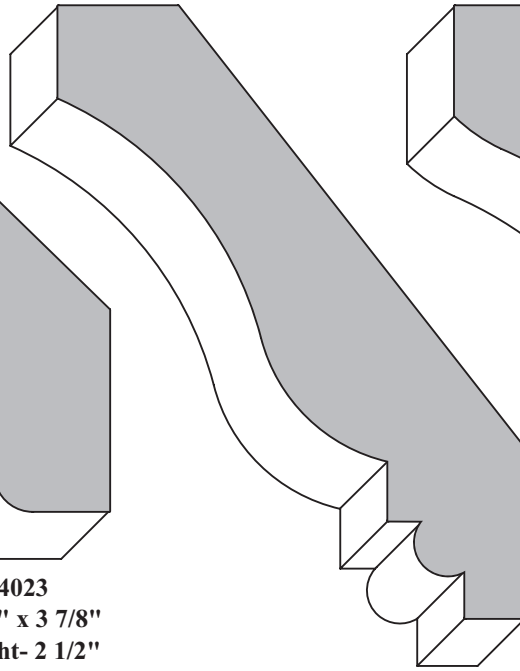

4006
3/4" x 4"
Height- 3 3/16"
Proj. - 2 7/16"

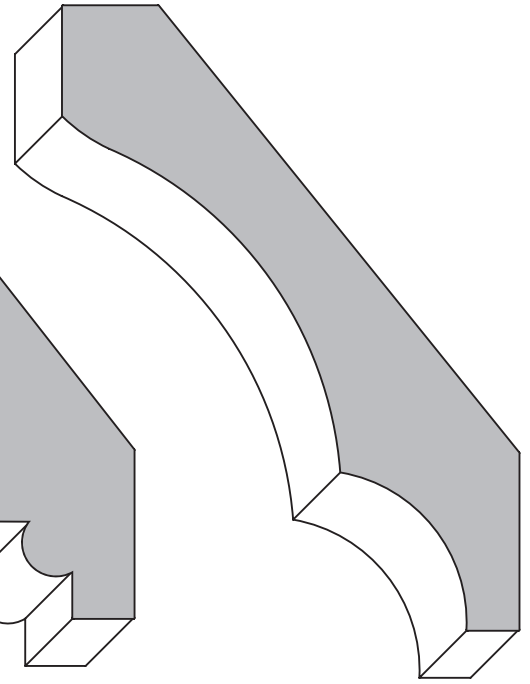

4007
3/4" x 4"
Height- 3 1/4"
Proj. - 2 3/8"

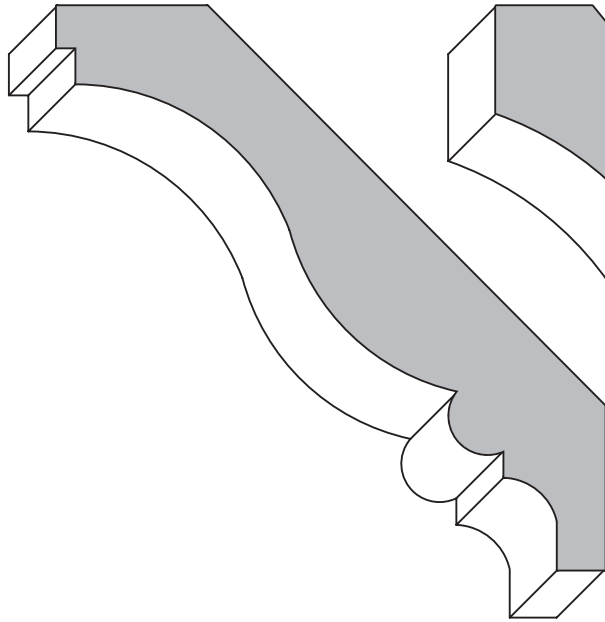

4033
3/4" x 4 1/8"
Height - 2 15/16"
Proj. - 2 7/8"

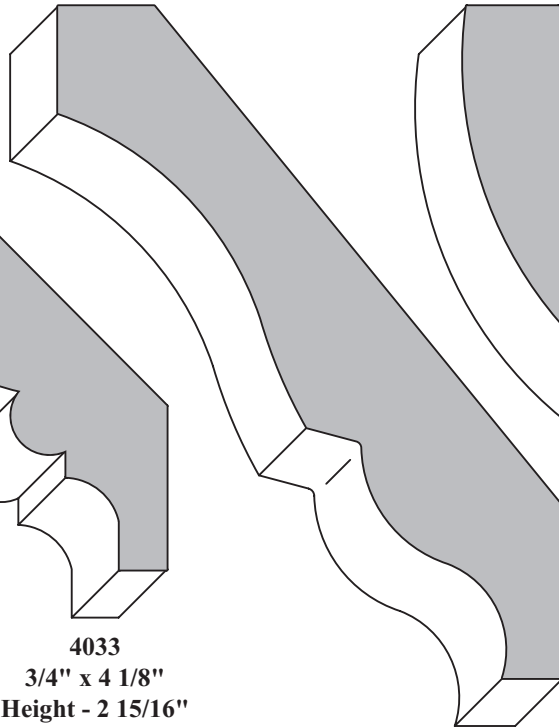

4008
3/4" x 4 3/8"
Height - 3 1/2"
Proj. - 2 5/8"

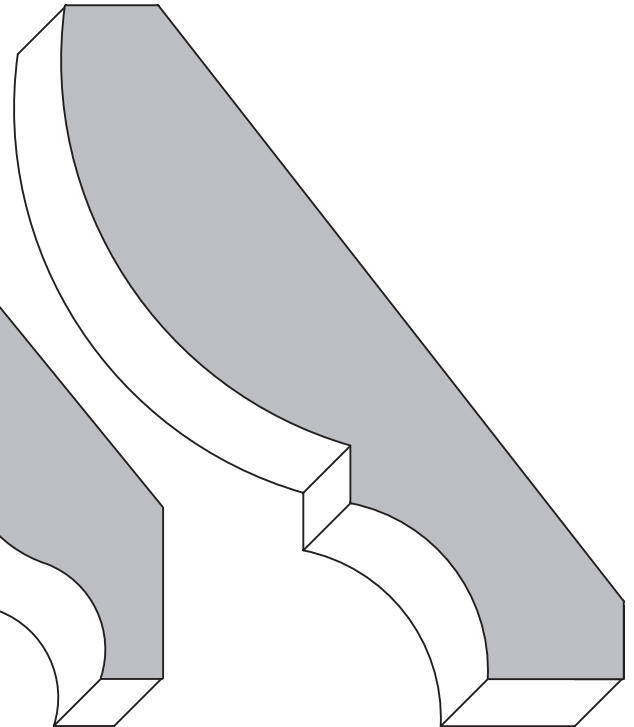

4034
1" x 4 1/2"
Height - 3 1/2"
Proj. - 2 15/16"

Crowns are not adjustable

Wood Originals

15

Phone: (970) 352-7688

Fax: (970) 352-7689

Crown

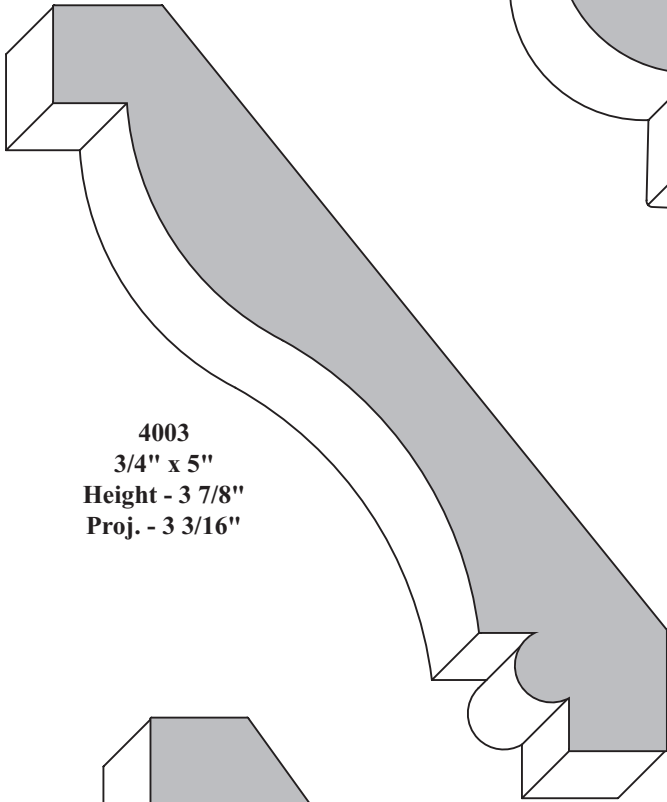

4003
3/4" x 5"
Height - 3 7/8"
Proj. - 3 3/16"

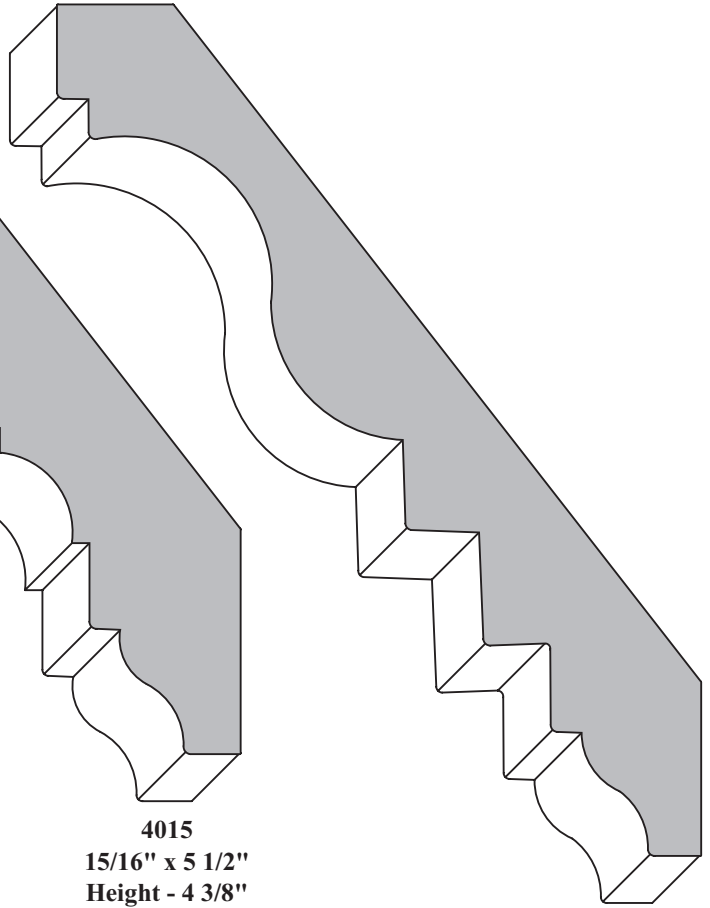

4015
15/16" x 5 1/2"
Height - 4 3/8"
Proj. - 3 5/16"

4017
13/16" x 5 1/2"
Height - 4 3/8"
Proj. - 3 5/16"

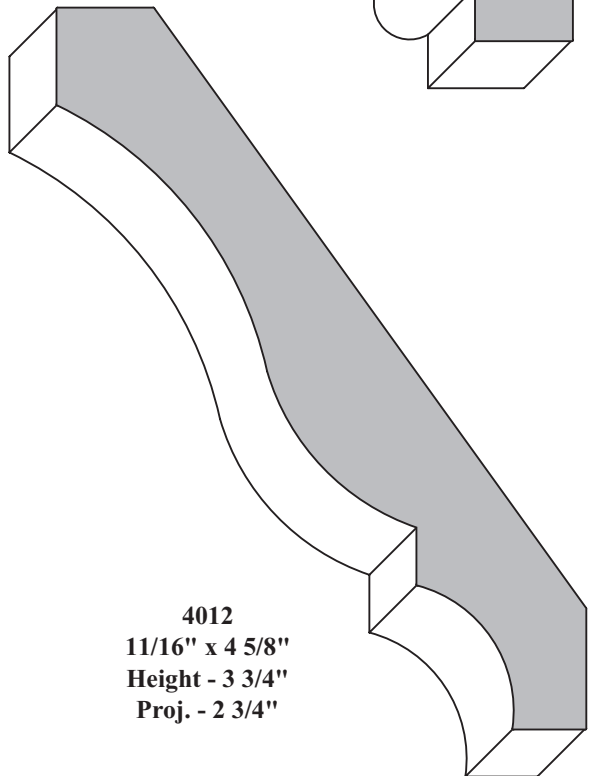

4012
11/16" x 4 5/8"
Height - 3 3/4"
Proj. - 2 3/4"

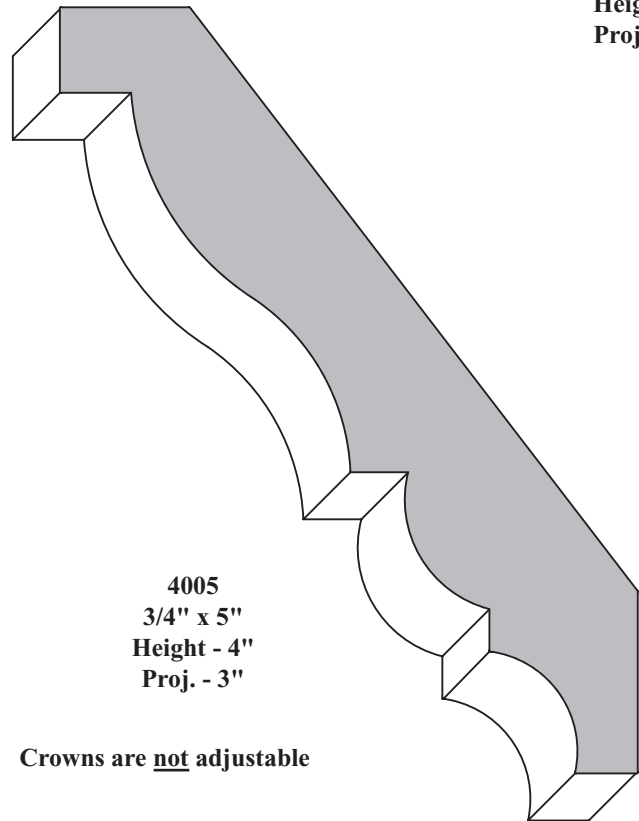

4005
3/4" x 5"
Height - 4"
Proj. - 3"

Crowns are not adjustable

Crown

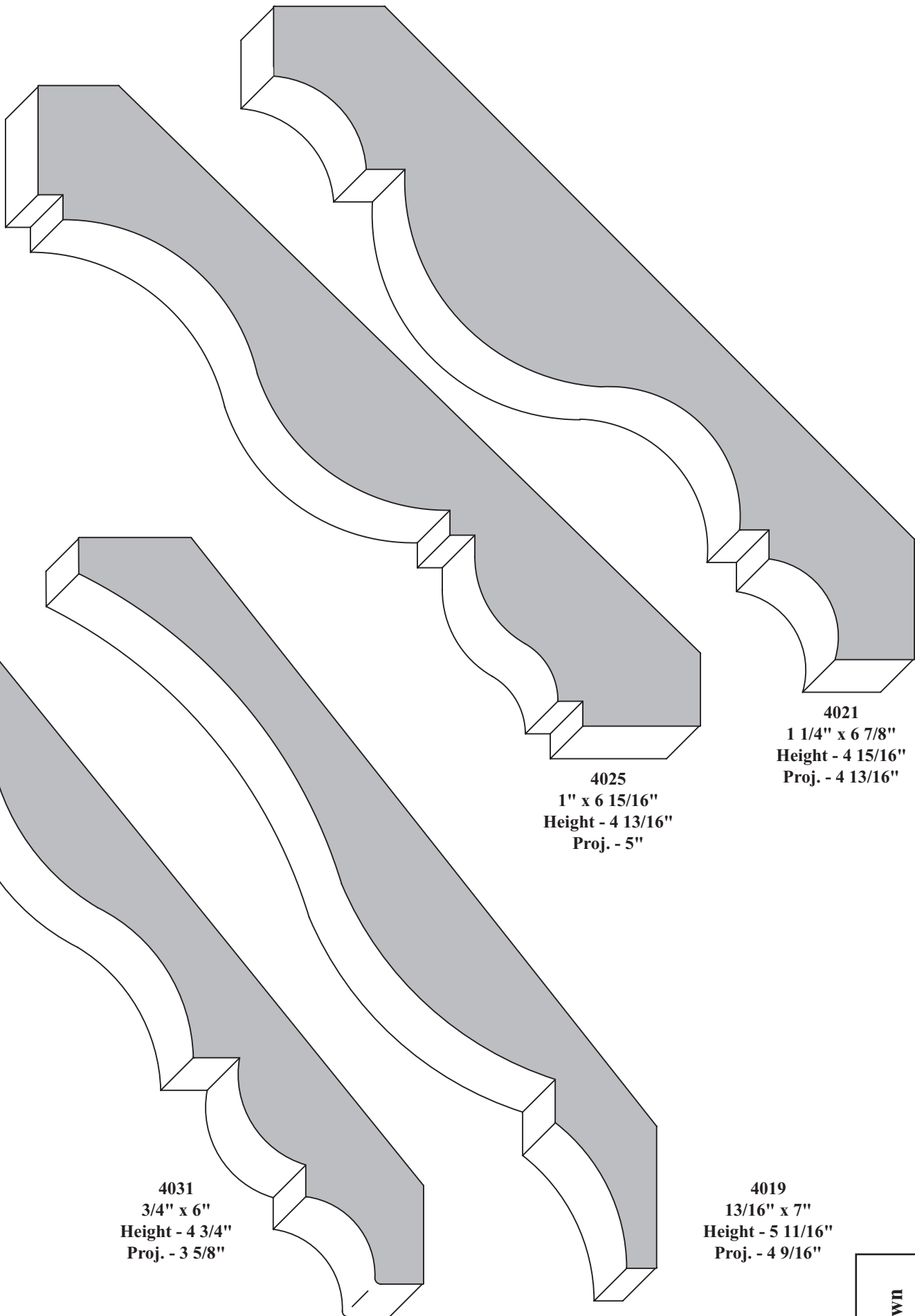

4021
1 1/4" x 6 7/8"
Height - 4 15/16"
Proj. - 4 13/16"

4025
1" x 6 15/16"
Height - 4 13/16"
Proj. - 5"

4031
3/4" x 6"
Height - 4 3/4"
Proj. - 3 5/8"

4019
13/16" x 7"
Height - 5 11/16"
Proj. - 4 9/16"

Crowns are not adjustable

Wood Originals

Phone: (970) 352-7688

Fax: (970) 352-7689

Crown

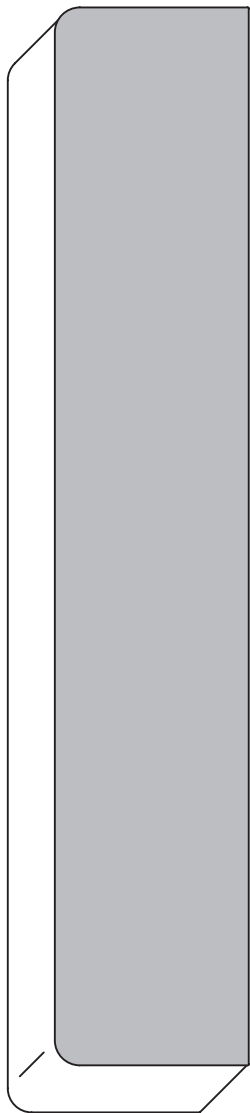

E2E 1/8" Header
1" x (9" max.)
Shown at 5 1/2"

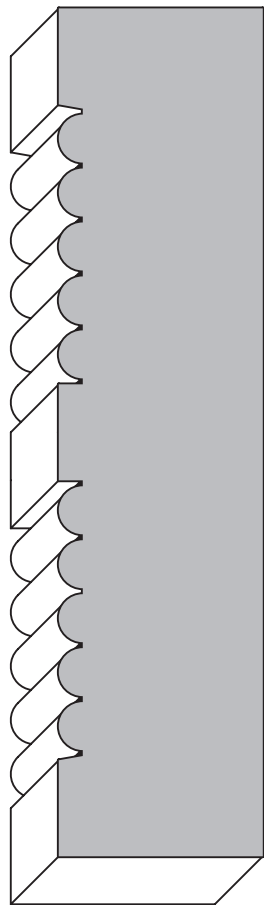

3043
1 1/16" x
(4 7/16" max.)

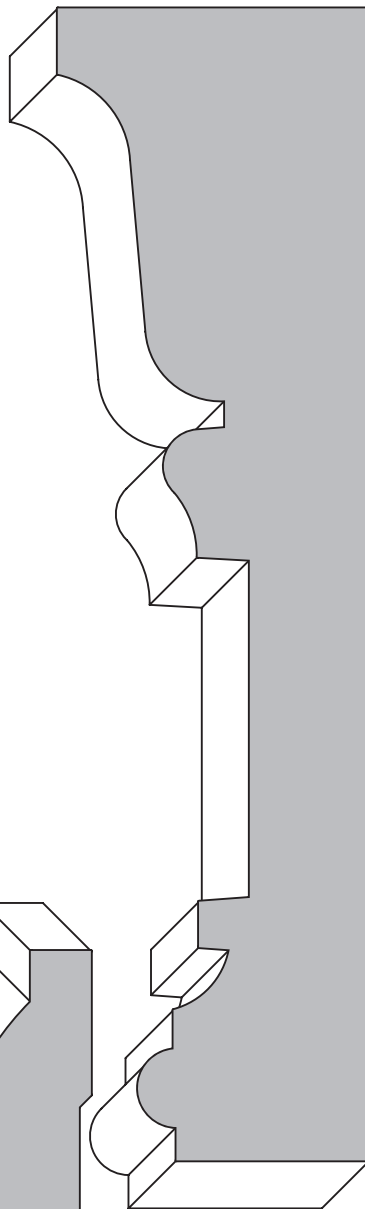

4014
1 5/8" x
(6" max.)



5003
3/4" x
(4 1/2" max.)

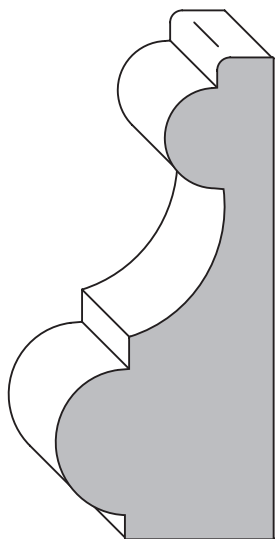

5008
1 1/8" x
(2 1/2" max.)

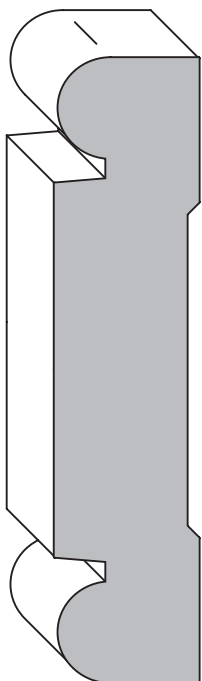

5011
3/4" x
(3 1/4" max.)

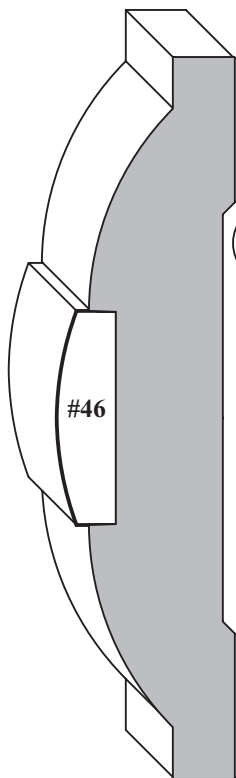

5012
3/4" x
(3 3/4" max.)
5/16" x
(1 1/8" max.)
(Acc. 46 Inlay)

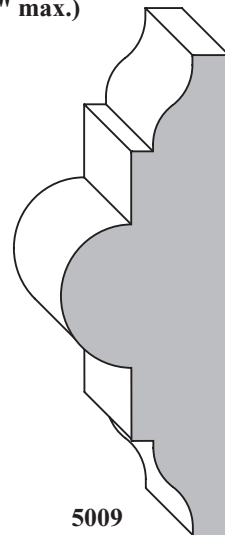

5009
7/8" x
(2 1/2" max.)

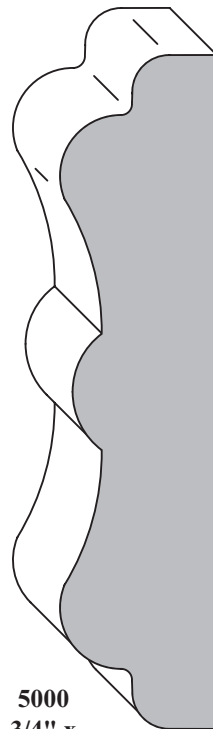

5000
3/4" x
(3 1/2" max.)

**Header,
Pediment,
Chair Rail**

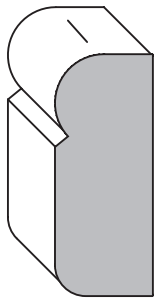

5013
1/2" x
(1 1/4" max.)

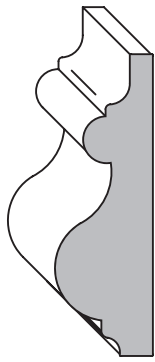

5007
1/2" x
(1 9/16" max.)

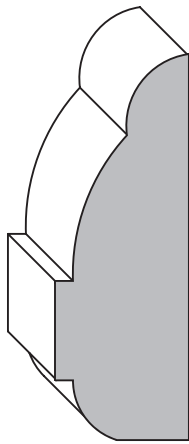

5010
11/16" x
(2" max.)

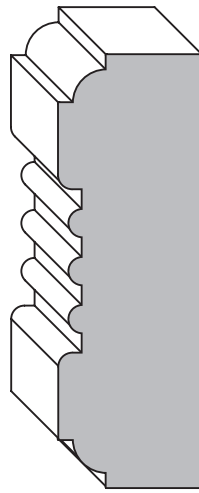

5001
3/4" x
(2 1/4" max.)



5006
3/8" x
(9" max.)
Shown at 2 1/4"

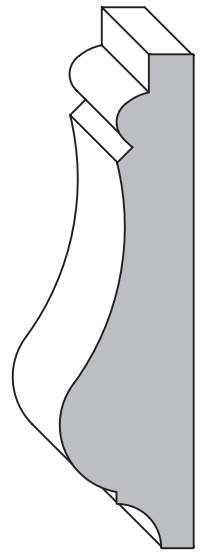

5002
11/16" x
(2 9/16" max.)

Chair Rail

Ballusters

Acc. 41
3/4" x 3/4"
E4E 1/8"

Acc. 27
7/8" x 7/8"
E4E 1/4"

Acc. 64
1" x 1"
E4E 1/8"

3020
1" x 1"
E4E 1/4"

3010
1 1/8" x 1 1/8"
E4E 3/32"

Acc. 28
1 1/4" x 1 1/4"
E4E 1/16"

Acc. 43
1 5/16" x 1 5/16"
E4E 1/16"

Acc. 70
1 3/8" x 1 3/8"
E4E 1/16"

Acc. 23
1 1/2" x 1 1/2"
E4E 1/16"

Acc. 51
1 1/2" x 1 1/2"
E4E 3/32"

3004
1 1/2" x 1 1/2"
E4E 1/4"

Acc. 40
1 5/8" x 1 5/8"
E4E 1/8"

Acc. 25
1 3/4" x 1 3/4"
E4E 1/16"

Acc. 50
1 3/4" x 1 3/4"
E4E 1/8"

Wood Originals

Phone: (970) 352-7688

Fax: (970) 352-7689

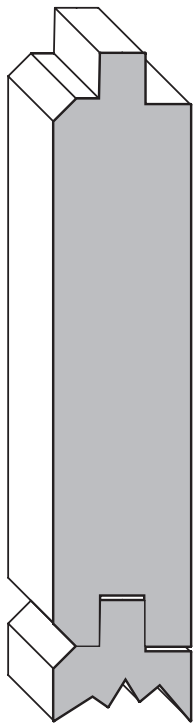

6000
 3/4" x 3" (face)
 Up to 8 3/4" (face)
 Add 1/4" for tongue

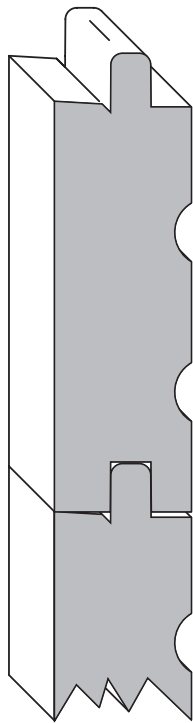

6001
 3/4" x 2 1/4"
 (face) Flooring
 Up to 9" (face)
 Add 1/4" for tongue

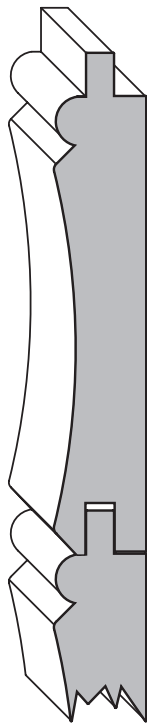

7003
 1/2" x 2 1/2"
 (max. face)
 Add 1/4"
 for tongue

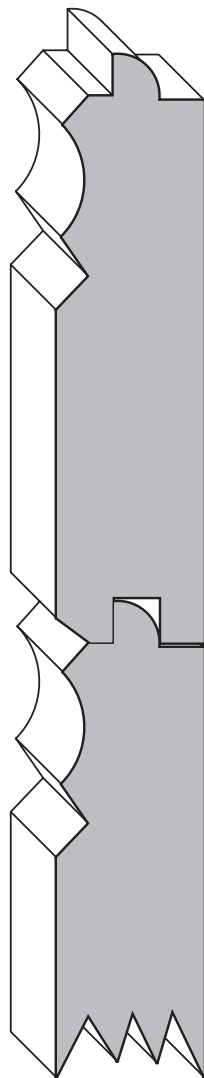

7004
 13/16" x 3" (face)
 9" (max. face)
 Add 1/4" for tongue
 Special setup required

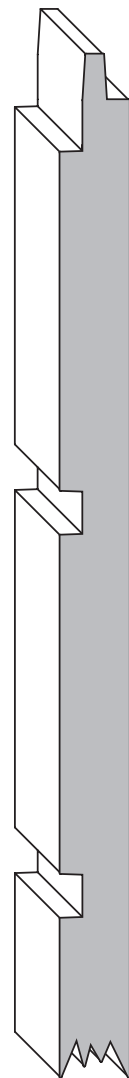

7005
 3/8" x 6 3/8"
 (max. face)
 Add 1/4"
 for tongue

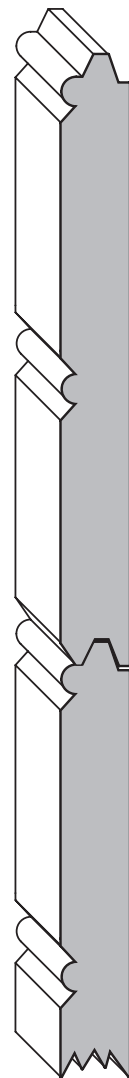

7006
 3/8" x 3 1/4"
 (max. face)
 Add 1/8" for tongue

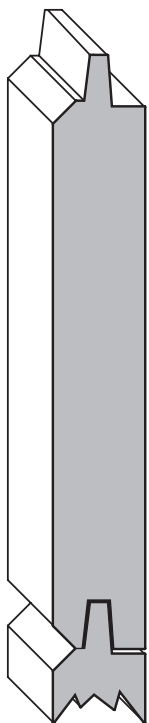

7007
 1/2" x
 3" (face)
 (9" max. face)
 This profile
 can't be thinned up.

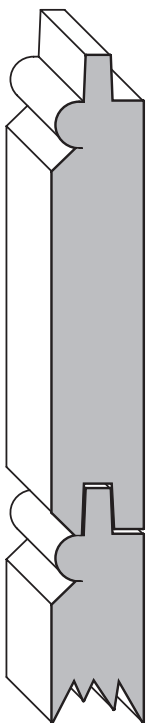

7008
 1/2" x 2 3/8"
 (max. face)
 Add 1/4"
 for tongue

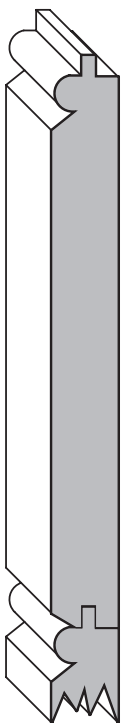

7009
 3/8" x 3"
 (max. face)
 Add 1/8"
 for tongue

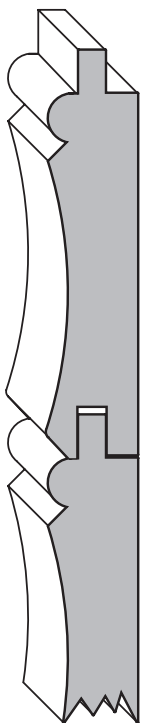

7010
 1/2" x 2"
 (max. face)
 Add 1/4"
 for tongue

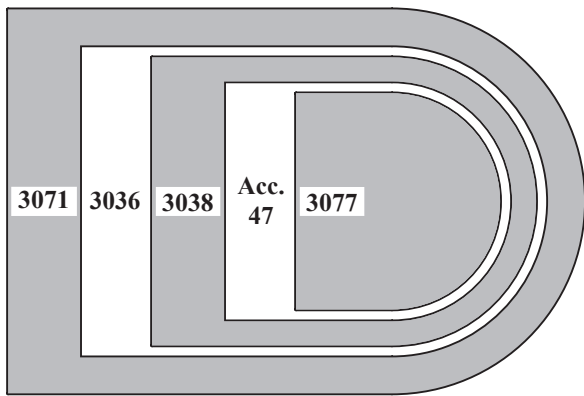

3071 - 2" Bullnose
 3036 - 1 5/8" Bullnose
 3038 - 1 1/2" Bullnose
 Acc. 47 - 1 1/4" Bullnose
 3077 - 1 1/8" Bullnose

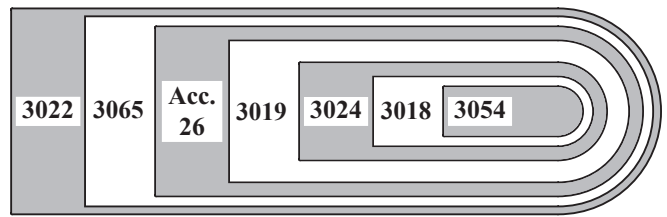

3022 - 1 1/16" Bullnose
 3065 - 1" Bullnose
 Acc. 26 - 7/8" Bullnose
 3019 - 3/4" Bullnose
 3024 - 1/2" Bullnose
 3018 - 3/8" Bullnose
 3054 - 1/4" Bullnose

Bullnose can be made up to 9" wide.

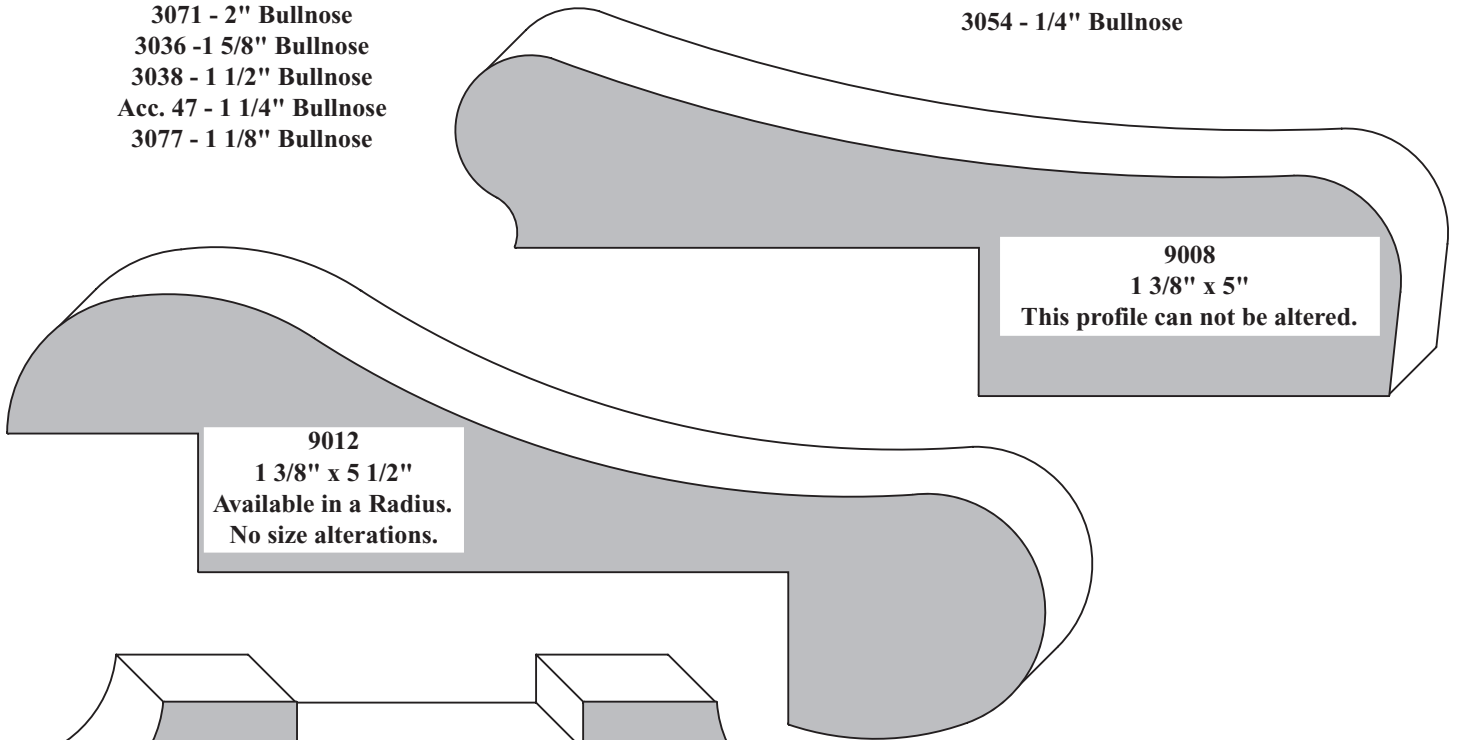

9012
 1 3/8" x 5 1/2"
 Available in a Radius.
 No size alterations.

9008
 1 3/8" x 5"
 This profile can not be altered.

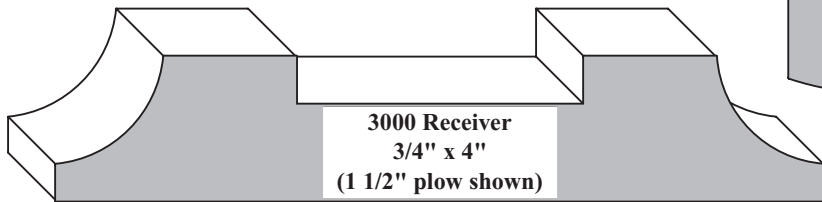

3000 Receiver
 3/4" x 4"
 (1 1/2" plow shown)

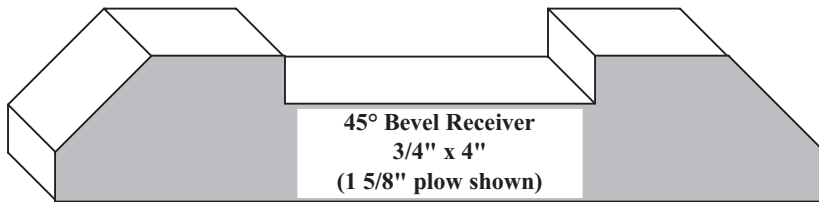

45° Bevel Receiver
 3/4" x 4"
 (1 5/8" plow shown)

Receivers available in different sizes and configurations.

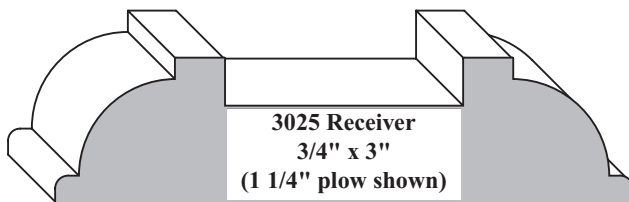

3025 Receiver
 3/4" x 3"
 (1 1/4" plow shown)

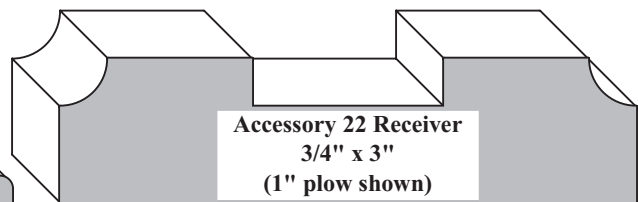

Accessory 22 Receiver
 3/4" x 3"
 (1" plow shown)

Plow availability depends on
Hand Rail profile.

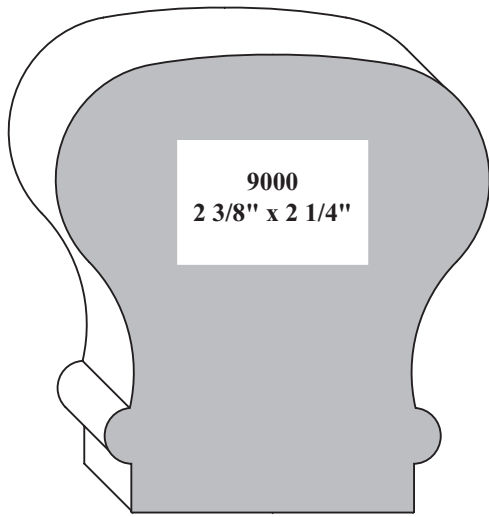

9000
2 3/8" x 2 1/4"

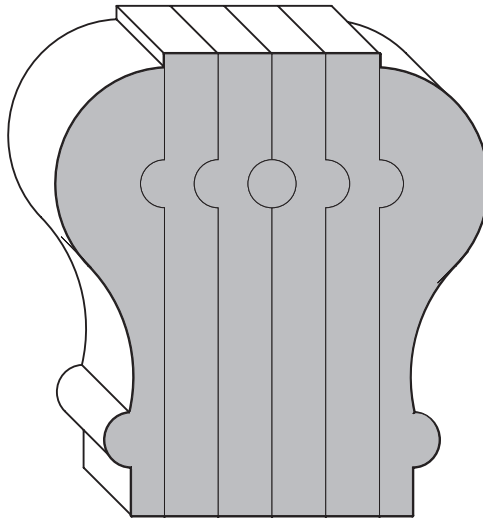

9000 Bendable
2 3/8" x 2 1/4"
Comes with
negative for clamping

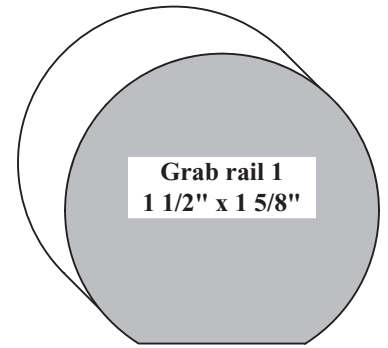

Grab rail 1
1 1/2" x 1 5/8"

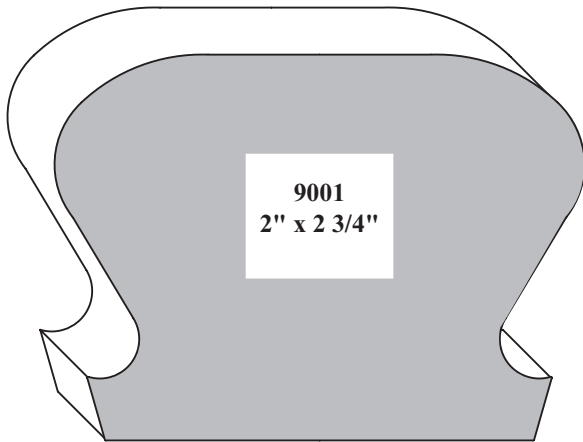

9001
2" x 2 3/4"

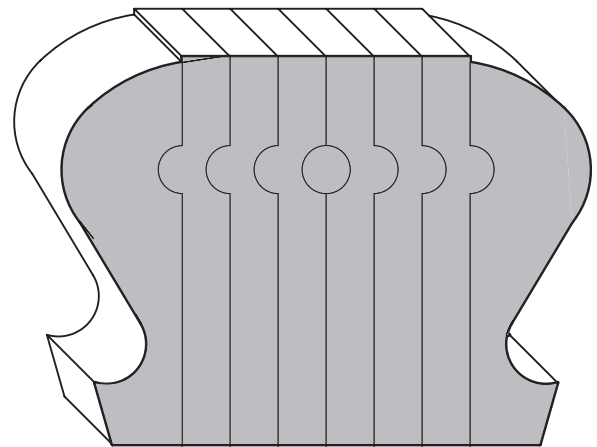

9001 Bendable
2" x 2 3/4"
Comes with negative
for clamping

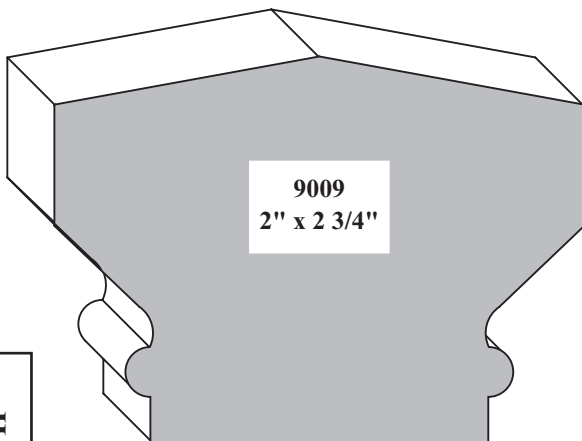

9009
2" x 2 3/4"

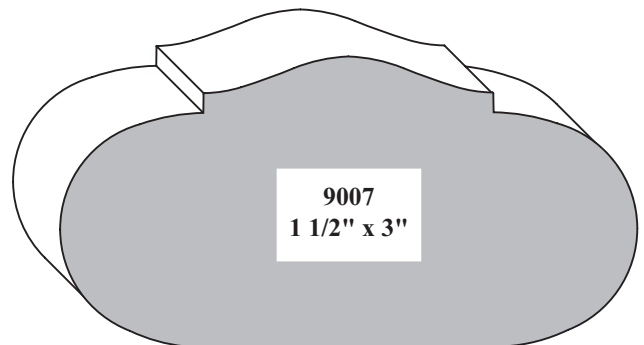

9007
1 1/2" x 3"

Hand
Rail

Plow availability depends on Hand
Rail profile.

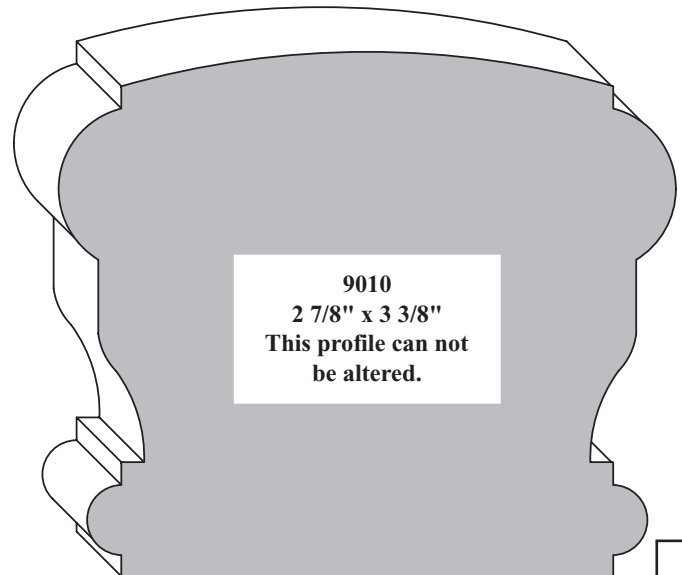
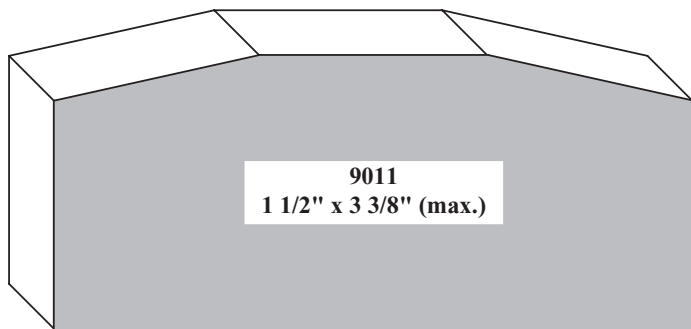
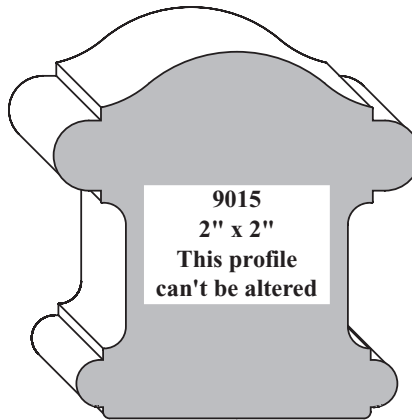
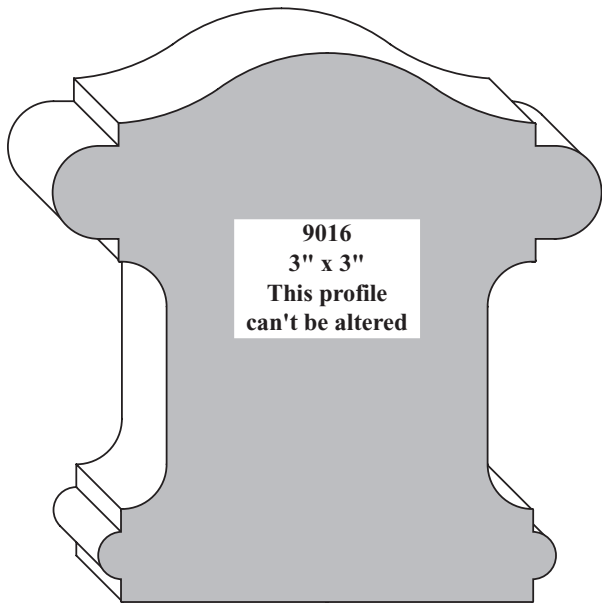
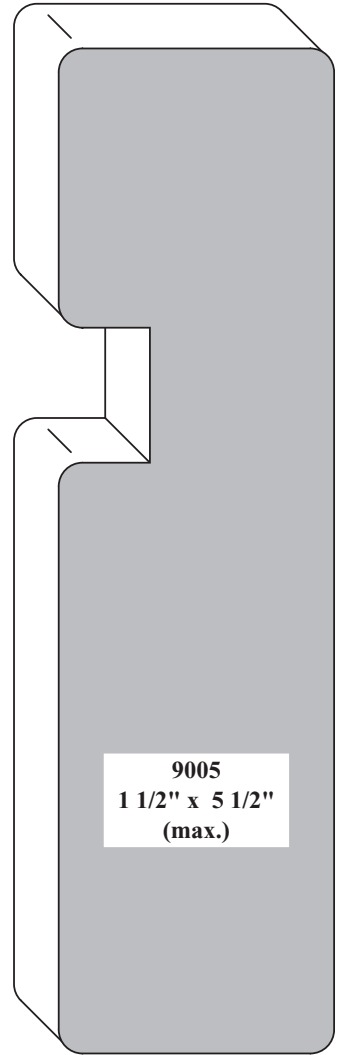
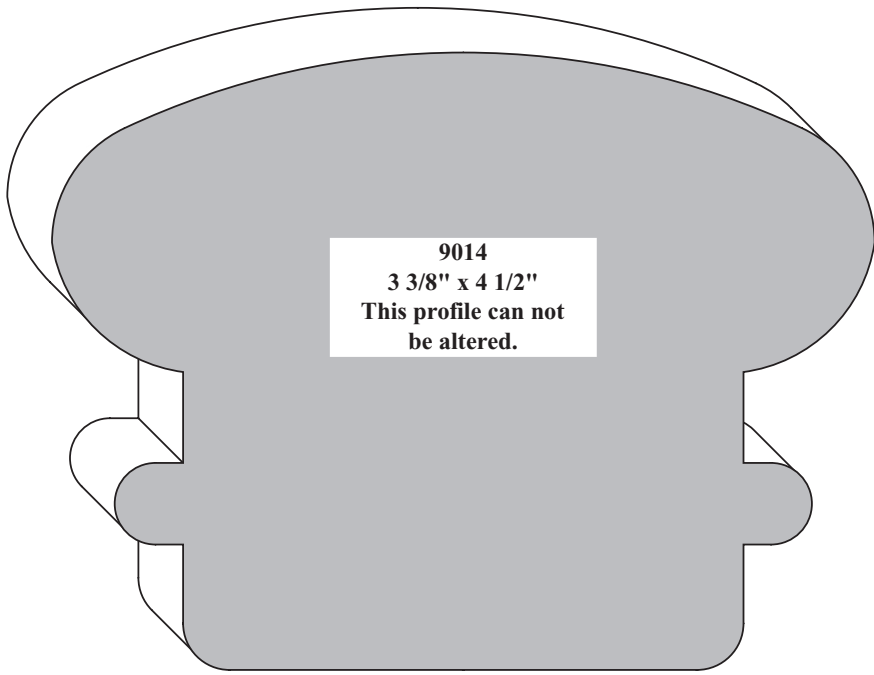

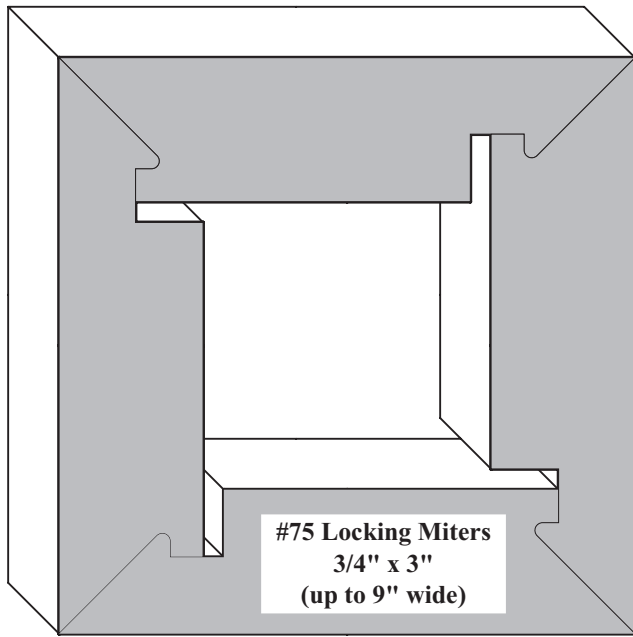

**Great for
Newel Posts**

**#76 Octagon Miters 3/4" x 1 1/2"
(up to 9" wide)
(Makes approx. 3 5/8"
Diameter piece @ 1 1/2")**

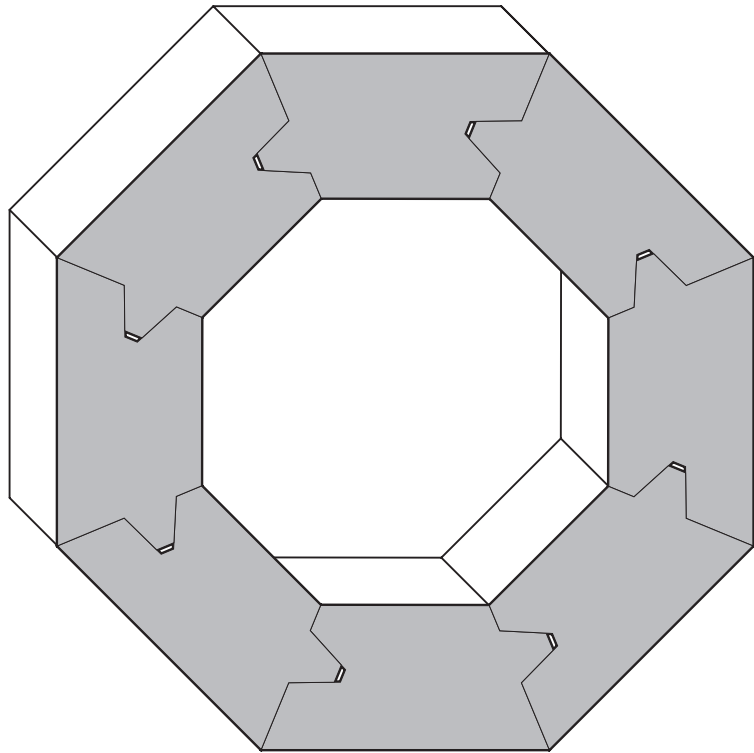

**45° Locking
Miter,
Octagon**

Wood Originals

Phone: (970) 352-7688

24

Fax: (970) 352-7689